

Dell™ Latitude™ CPx H-Series/J-Series User's Guide

[Preface](#)

[Introduction](#)

[Setup and Operation](#)

[Powering Your Computer](#)

[Intel SpeedStep Options](#)

[Traveling With Your Computer](#)

[Drivers](#)

[Customizing Your Computer](#)

[Removing and Replacing Parts](#)

[Troubleshooting Your Computer](#)

[Technical Specifications](#)

[Getting Help](#)

Information in this document is subject to change without notice.

© 1999 – 2000 Dell Computer Corporation. All rights reserved.

Reproduction in any manner whatsoever without the written permission of Dell Computer Corporation is strictly forbidden.

Trademarks used in this text: *Dell*, *Latitude*, *Dimension*, *Inspiron*, *Optiplex*, *ExpressCharge*, *HyperCool*, and *DellWare* are trademarks of Dell Computer Corporation; *Microsoft*, *Windows*, *Windows NT*, and *MS-DOS* are registered trademarks of Microsoft Corporation; *Intel* and *Pentium* are registered trademarks and *SpeedStep* is trademark of Intel Corporation. As an ENERGY STAR partner, Dell Computer Corporation has determined that this product meets the ENERGY STAR guidelines for energy efficiency.

Other trademarks and trade names may be used in this document to refer to either the entities claiming the marks and names or their products. Dell Computer Corporation disclaims any proprietary interest in trademarks and trade names other than its own.

This product incorporates copyright protection technology that is protected by method claims of certain U.S. patents and other intellectual property rights owned by Macrovision Corporation and other rights owners. Use of this copyright protection technology must be authorized by Macrovision Corporation and is intended for home and other limited viewing uses only unless otherwise authorized by Macrovision Corporation. Reverse engineering or disassembly is prohibited.

Model PPX

Initial release: 15 Nov 1999

Last revised: 28 Aug 2000

Preface: Dell™ Latitude™ CPx H-Series/J-Series User's Guide

[About This Guide](#)

[Notational Conventions](#)

[Warranty and Return Policy Information](#)

[Typographical Conventions](#)

[Other Documents You May Need](#)

About This Guide

This guide is intended for anyone who uses the Dell Latitude CPx H-Series/J-Series portable computers. It can be used by both first-time and experienced computer users who want to learn about the features of the computer. This guide also provides basic troubleshooting procedures and instructions for using the Dell Diagnostics to test your computer and its components. The sections are summarized as follows:

- "[Introduction](#)" — overview of the computer features and available upgrades
 - "[Setup and Operation](#)" — instructions on operating your computer
 - "[Powering Your Computer](#)" — instructions and options on how to power your computer
 - "[Traveling With Your Computer](#)" — suggestions on how to travel safely with your computer
 - "[Drivers](#)" — instructions on how to install driver software on your computer
 - "[Customizing Your Computer](#)" — instructions on accessing the System Setup program, power management software, and the Suspend-to-Disk utility, all of which allow you to change system settings affecting your computer's power conservation features
 - "[Removing and Replacing Parts](#)" — instructions on how to remove and install hard-disk drives and memory modules
 - "[Troubleshooting Your Computer](#)" — initial checks and procedures that can be used to solve basic computer problems, general guidelines on analyzing software problems, messages, and beep codes
 - "[Technical Specifications](#)" — reference material about the details of your computer
 - "[Getting Help](#)" — help tools Dell provides to assist you if you have a problem with the computer and explains how and when to call Dell for technical assistance
-

Warranty and Return Policy Information

Dell Computer Corporation ("Dell") manufactures its hardware products from parts and components that are new or equivalent to new in accordance with industry-standard practices.

For information about the Dell warranty and return policy, see the *System Information* guide that came with your computer.

Other Documents You May Need

Besides this *User's Guide*, the following documentation is included with your computer:



*NOTE: Documentation updates are sometimes included with your computer to describe changes to your computer or software. Always read these updates **before** consulting any other documentation because the updates contain the latest information.*

- An operating system *Setup Guide*, which describes how to set up the operating system installed on your Dell computer.
- Operating system documentation is included if you ordered your operating system from Dell. This documentation describes how to configure and use your operating system software.
- Documentation is included with any options you purchase separately from your computer. This documentation includes information that you need to configure and install these options in your Dell computer.
- "Readme" files may be installed on your hard-disk drive to provide last-minute updates about technical changes to your computer or advanced technical reference material intended for experienced users or technicians.

Notational Conventions

The following subsections list notational conventions used in this document.

Notes, Notices, and Cautions

Throughout this guide, blocks of text may be accompanied by an icon and printed in bold type or in italic type. These blocks are notes, notices, and cautions, and they are used as follows:



NOTE: A NOTE indicates important information that helps you make better use of your computer.

NOTICE: A NOTICE indicates either potential damage to hardware or loss of data and tells you how to avoid the problem.



CAUTION: A CAUTION indicates a potentially hazardous situation which, if not avoided, may result in minor or moderate injury.

Typographical Conventions

The following list defines (where appropriate) and illustrates typographical conventions used as visual cues for specific elements of text throughout this document:

- *Interface components* are window titles, button and icon names, menu names and selections, and other options that appear on the monitor screen or display. They are presented in bold.

Example: Click **OK**.

- *Keycaps*, the labeling that appears on the keys on a keyboard, are enclosed in angle brackets.

Example: <Enter>

- *Key combinations* are series of keys to be pressed simultaneously (unless otherwise indicated) to perform a single function.

Example: <Ctrl><Alt><Enter>

- *Commands* presented in lowercase bold are for reference purposes only and are not intended to be typed at that particular point in the discussion.

Example: "Use the **setup** command to"

In contrast, commands presented in the Courier New font are intended to be typed as part of an instruction.

Example: "Type `format` to format the diskette in drive A."

- *Filenames* and *directory names* are presented in lowercase bold.

Examples: **autoexec.bat** and **c:\windows**

- *Syntax lines* consist of a command and all its possible parameters. Commands are displayed in lowercase bold; variable parameters (those for which you substitute a value) are displayed in lowercase italics; constant parameters are displayed in lowercase bold. The brackets indicate items that are optional.

Example: **del** [*drive:*] [*[path]filename*] [**/p**]

- *Command lines* consist of a command and may include one or more of the command's possible parameters. Command lines are presented in the Courier New font.

Example: `del c:\myfile.doc`

- *Screen text* is text that appears on the screen of your display or external monitor. It can be a system message, for example, or it can be text that you are instructed to type as part of a command (referred to as a *command line*). Screen text is presented in the Courier New font.

Example: The following message appears on your screen:

```
No boot device available
```

- *Variables* are symbols for which you substitute a value. They are presented in italics.

Example: module *n* (where *n* represents the memory module number)

[Back to Contents Page](#)

Introduction: Dell™ Latitude™ CPx H-Series/J-Series User's Guide

[Overview](#)

[Available Options](#)

[Features](#)

[Getting Help](#)

Overview

The Dell Latitude CPx H-Series/J-Series portable computers are expandable multimedia systems using the latest Intel® Mobile Pentium® technology. In addition, the J-Series supports Intel SpeedStep™ technology. The CPx H-Series/J-Series computers include the Dell DualPoint integrated pointing device, which provides a touch pad and a track stick to control the cursor on the display screen. This section describes the major hardware and software features of your computer. [Figure 1](#) and [Figure 2](#) show the front and back view of the computer, respectively.

Figure 1. Front View of the Computer

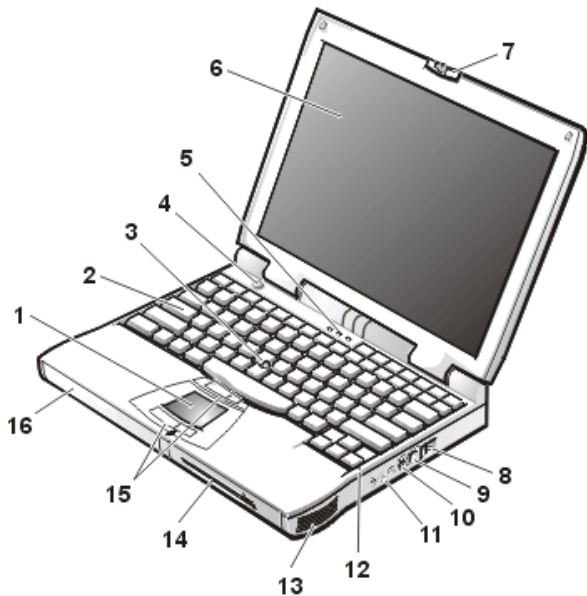

- 1 Touch pad
- 2 Keyboard
- 3 Track stick
- 4 Power button
- 5 Keyboard status LEDs
- 6 Display
- 7 Display latch
- 8 Air intake
- 9 Internal modem connector (available only on CPt S-Series)
- 10 S-Video connector
- 11 Audio jacks (3)

- 12 Integrated microphone
- 13 Speaker
- 14 Modular bay
- 15 DualPoint buttons
- 16 Battery bay

Figure 2. Back View of the Computer

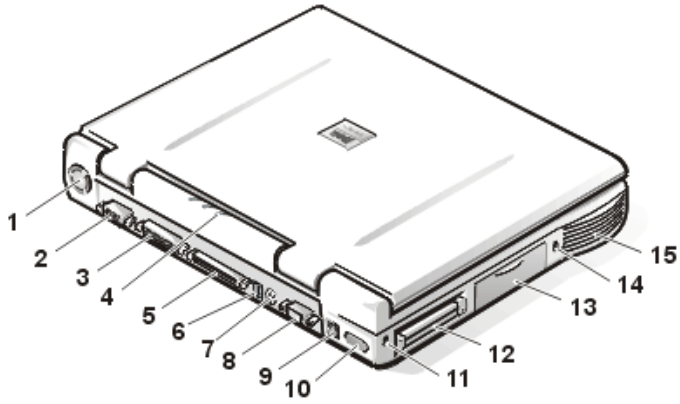

- 1 Fan
- 2 Video connector
- 3 Parallel connector
- 4 Status indicator panel
- 5 Docking connector
- 6 USB connector
- 7 PS/2 connector
- 8 Serial connector
- 9 AC adapter connector
- 10 Infrared port
- 11 Security cable slot
- 12 PC Card slots (2)
- 13 Hard-disk drive
- 14 Security cable slot
- 15 Speaker

Features

Your Dell computer has the following features:

- Full multimedia capability through the following standard features:
 - A 14.1-inch extended graphics array (XGA), thin film transistor (TFT) 1024 x 768 active-matrix color display.
 - A CD-ROM drive that can be used in the modular bay. When you unpack your computer, look for the CD-ROM drive in the accessories box of the shipping carton.

- 64-bit hardware-accelerated video support, with 8 megabytes (MB) of video memory.
- Support for a zoomed video (ZV) PC Card in the lower PC Card connector.
- For H-Series computers, ESS Maestro 2E audio controller with hardware wavetable support and 3D surround sound.
- For J-Series computers, ESS Maestro 3I audio controller with software wavetable support and 3D surround sound.
- Three audio jacks for connecting external speakers or headphones, a microphone, and a record/playback device to your computer.
- Integrated microphone and two stereo speakers.
- Accelerated graphics port (AGP) architecture that increases the computer's performance, particularly video performance.
- An ENERGY STAR® partner, Dell Computer Corporation has determined that this product meets the ENERGY STAR guidelines for energy efficiency.
- A modular bay that supports a DVD-ROM drive, CD-ROM drive, CD-RW drive, diskette drive, second battery, second hard-disk drive, or SuperDisk LS-120 drive module. To make the computer as light as possible when you travel, use the special travel module in the modular bay.



NOTE: Your computer was shipped with a diskette drive in the modular bay. For information on removing the diskette drive and installing a different device in the bay, see "[Modular Bay](#)."

- A minimum of 32-MB synchronous dynamic random-access memory (SDRAM) module is standard. You can increase memory up to 512 MB by installing combinations of 32-, 64-, 128-, 192-, or 256-MB SDRAM modules in the two memory module sockets on the system board.



NOTE: Your computer is capable of supporting two 256-MB SDRAM modules for a total of 512 MB of memory.

- Two power conservation modes — *suspend mode* and *suspend-to-disk mode* — that help you conserve battery power. If the batteries run out of power, suspend-to-disk mode prevents data loss by copying all system data to the hard-disk drive and turning off the computer.
- Connectors for two 3.3-volt (V) or 5-V PC Cards. The lower PC Card connector supports ZV PC Cards.



NOTE: The PC Card controller supports the CardBus standard for 32-bit data transfer on the PC Card.

- Hardware and software support for the Dell Latitude C/Port Family Advanced Port Replicator (APR) and the Dell Latitude C/Dock Family Expansion Station.
- A DualPoint integrated pointing device which includes both a touch pad and a track stick. These pointing devices are positioned for both left- and right-handed users. The track stick is positioned in the keyboard to allow you to move the cursor while keeping your fingers in a typing position. Two sets of left and right buttons, located above and below the touch pad, mimic mouse buttons. You can also perform many pointing functions by tapping the touch pad or the track stick. Click-and-drag buttonless functions are also supported.
- A lithium ion battery in the battery bay, with support for a second battery in the modular bay. The Dell ExpressCharge™ technology charges a single battery in approximately 1 hour (when the computer is off or in suspend mode).

NOTICE: Do not puncture or incinerate the battery. When your battery no longer holds a charge, call your local waste disposal agency or environmental agency for advice on disposing of the computer's lithium ion battery. The lithium ion technology used in the battery is significantly less hazardous to the environment than the lithium metal technology used in some other batteries (such as watch batteries).

- High-performance parallel and serial ports and a multipurpose Personal System/2 (PS/2) connector for attaching external devices, a monitor connector for attaching an external monitor to your computer, and a Universal Serial Bus (USB) connector that supports stand-alone and hub devices.
- An infrared port that permits file transfer without the use of cable connections. The port is compatible with the Infrared Data Association (IrDA) Standard 1.1 (Fast IR) and Standard 1.0 (Slow IR) for use with external devices.
- Dell HyperCool™ an automatic thermal management system that uses a variable-speed fan, microprocessor speed changes, and Intel's Remote Heat Exchanger technology to keep the system running at the optimum temperature.

 **CAUTION: Do not allow your Latitude portable computer to operate with the base resting directly on exposed skin. With extended operation, heat can potentially build up in the base. Allowing sustained contact with the skin could cause discomfort or, eventually, a burn.**

The following software is included with your Dell computer:

- The Microsoft® Windows® 95, Windows 98 Second Edition (SE), or Windows NT® 4.0, Windows 2000 or higher operating system is installed on your hard-disk drive. For more information, see your operating system documentation.
- For Latitude CPx J-Series computers, the Intel SpeedStep technology is installed on your hard-disk drive.
- The System Setup program lets you view and change the system configuration. For more information, see "[Using the System Setup Program](#)."
- [Dell Diagnostics](#) for evaluating the computer's components and devices.

 **NOTE:** If Dell did not install an operating system on your hard-disk drive, the drivers, system utilities, and diagnostics are available separately from Dell. To order them, see "[Getting Help](#)" for the appropriate telephone number in your location.

Available Options

As your computing requirements change, you can extend your computer's capabilities with a C/Port Family APR or C/Dock Family Expansion Station. You can also install a hard-disk drive of larger capacity, increase system memory, and add functionality with PC Cards. Dell also offers additional modules that you can install in the modular bay, including a second hard-disk drive, a DVD-ROM drive, a CD-ROM drive, a CD-RW drive, an LS-120 drive module, and a second battery.

Dell offers the following devices and upgrade options:

- C/Port Family APRs and C/Dock Family Expansion Stations
- Additional batteries
- External keyboards and a numeric keypad
- External monitors
- External pointing devices
- External speakers, headphones, and microphones
- Printers
- Hard-disk drives
- Second hard-disk drive for the modular bay
- DVD-ROM drive modules
- CD-RW drive modules
- Second CD-ROM drive module

- SuperDisk LS-120 drive modules
- AC adapter
- PC Cards
- 32-, 64-, 128-, 192-, and 256-MB memory modules
- Carrying case

Instructions for connecting or installing these options are included in the upgrade kit you receive from Dell.

Getting Help

If at any time you don't understand a procedure described in this guide, or if your computer does not perform as expected, Dell provides a number of tools to help you. For more information on these help tools, see "[Getting Help](#)."

[Back to Contents Page](#)

[Back to Contents Page](#)

Setup and Operation: Dell™ Latitude™ CPx H-Series/J-Series User's Guide

 [AC Adapter](#)

 [PC Cards](#)

 [Batteries](#)

 [Modular Bay](#)

 [CD-ROM, DVD-ROM, and CD-RW
Drives](#)

 [DualPoint Integrated Pointing Device](#)

 [Display](#)

 [Securing Your Computer](#)

 [Diskette Drive](#)

 [Connecting External Devices](#)

 [Keyboard](#)

 [I/O Connectors](#)

[Back to Contents Page](#)

[Back to Contents Page](#)

Powering Your Computer: Dell™ Latitude™ CPx H-Series/J-Series User's Guide

 [AC Adapter](#)

 [Power Management Settings](#)

 [Batteries](#)

[Back to Contents Page](#)

Intel® SpeedStep™ Options: Dell™ Latitude™ CPx H-Series/J-Series User's Guide

 [Using Intel SpeedStep](#)

 [Using the Adjust Properties Option](#)

 [Setting the Advanced Options](#)

Using Intel SpeedStep

The Intel SpeedStep technology, included with the Latitude CPx J-Series, allows you to set the performance level of the processor whether the computer is running on battery or AC power.

To access the Intel SpeedStep properties window, perform the following steps:

1. Right click the flag icon in the system tray on the Windows® taskbar to access further performance level options. The following three options appear:
 - **Maximum Performance option** — switches your computer to the highest possible performance level even if the computer is running on battery
 - **Battery Optimized Performance option** — lets your computer run on performance level optimized for battery power even if the computer is connected to an electrical outlet
 - **Adjust Properties** — lets you change the more performance options
2. To change the performance level, click the desired option.

To access the Intel SpeedStep options when the flag icon is not visible on the taskbar and if your computer is running under ACPI, perform the following steps:

1. Click the **Start** button and point to **Settings**.
 2. Click **Control Panel**.
 3. Click **Power Management**.
 4. Select the **Intel SpeedStep** tab and select the options desired.
 5. After you make any changes, click **OK** to accept the settings and close the Intel SpeedStep window.
-

Using the Adjust Properties Option

1. To access the Intel SpeedStep option window, either right click the flag icon and click the **Adjust Properties** option or double click the flag icon.

The **Intel SpeedStep technology** options window opens.

2. You can adjust the following performance options:
 - **Automatically change performance when the power source changes** (the default) — changes the performance level of your computer automatically when it is running on battery or connected to an electrical outlet.
 - **Ask me before automatically changing performance** — when selected, the computer prompts you for confirmation before the computer changes performance level.
 - **Running on batteries** and **Plugged in** pull-down menus — change performance level options.
 3. Click **Apply** to accept the settings.
 4. Click **OK** to close the **Intel SpeedStep technology** options window.
-

Setting the Advanced Options

The **Advanced** options lets you disable various options. To set **Advanced** options, perform the following steps:

1. Click the flag icon in the Windows® system tray on the taskbar.
2. Click the **Adjust Properties** option.

The **Intel SpeedStep** window opens.

3. Click the **Advanced** button.

The **Advanced** window opens.

4. Click any of the following options:
 - **Disable Intel SpeedStep technology control.**
 - **Remove flag icon.**
 - **Disable audio notification when performance changes.**
 5. Click **Apply** to accept the settings.
 6. Click **OK** to close the **Intel SpeedStep technology** window.
-

[Back to Contents Page](#)

Traveling With Your Computer: Dell™ Latitude™ CPx H-Series/J-Series User's Guide

[Identifying Your Computer](#)

[Preparing Your Computer for Travel](#)

[Travel Tips](#)

Identifying Your Computer

As an antitheft measure, assign a primary password and a hard-disk drive password to prohibit unauthorized access to the computer.

Dell recommends that you follow these precautions before you travel with your computer:

- Write down your service tag number, and put it in a safe place separate from the computer or carrying case. If the computer is lost or stolen, use the service tag number when reporting to law enforcement officials and to Dell.
- Use a text editor (such as Microsoft® Windows® Notepad) to create a file called **if_found** in your root directory. Place information such as your name, address, and telephone number in this file. (For instructions on using the appropriate text editor, see the documentation that came with your operating system.)
- Attach your business card or other name tag to the computer.
- Contact your credit-card company and ask if it offers coded identification tags that allow your property to be returned to you without the risk of revealing your name, address, or telephone number.
- Use a permanent marking or stenciling device to write your driver's license number or some other unique identifying mark on the computer. If a lost or stolen computer is recovered, such marking identifies the computer as your property.

Service Tag Number

The service tag number is an alphanumeric code on a bar code label located on the bottom of the computer. The number is unique to your computer and allows Dell technical assistance personnel to identify the computer and its configuration quickly if you call for assistance.

If Your Computer Is Lost or Stolen

If your computer is lost or stolen, Dell suggests that you perform the following steps:

1. Call a law enforcement agency to report the lost or stolen computer.

Include the service tag number in your description of the computer. Ask that a case number be assigned, and write it down. Also write down the name, address, and telephone number of the law enforcement agency. If possible, obtain the name of the investigating officer.

If you know where the computer was lost or stolen, call a law enforcement agency in that area. If you do not know, call a law enforcement agency where you live.

2. If the computer belongs to a company, notify the security office of the firm.
3. Call Dell technical assistance to report the missing computer.

Provide the computer's service tag number, the case number, and the name, address, and telephone number of the law enforcement agency to which you reported the missing computer. If possible, give the name of the investigating officer.

The Dell support technician will log your report under the computer's service tag number and flag the computer as missing or stolen. If someone calls Dell for technical assistance and gives your service tag number, the computer is identified automatically as missing or stolen. The technician will attempt to get the phone number and address of the caller. Dell will then contact the law enforcement agency to which you made the report of the missing or stolen computer.

Preparing Your Computer for Travel

To prepare your computer for travel, perform the following steps:

1. Remove any external devices attached to the computer, and store them in a safe place. If a diskette is in the diskette drive, remove it. Remove any cables attached to installed PC Cards (you do not have to remove the PC Cards themselves).
2. To make the computer as light as possible, remove the storage drive from the modular bay and install the travel module.
3. To maximize battery life, check the charge on your battery. Then fully charge the battery and any spares you plan to carry with you.
4. Turn off the computer or press <Fn><a> to enter suspend-to-disk mode. (On a French keyboard, press <Fn><q>.)

NOTICE: When you disconnect the AC adapter from the computer, grasp the adapter cable's connector, not the cable itself, and pull gently but firmly to avoid damaging the cable.

- Disconnect the AC adapter.

NOTICE: When the display is closed, items left on the keyboard could damage the display.

6. Make sure that there is nothing on the keyboard and palmrest that can damage the display when you close it. Then close the display.
7. Pack all your computing accessories.

With the optional Dell carrying case, you can pack the computer and its accessories together.



NOTE: Follow the travel tips and take special precautions if you are planning to travel by air.

Accessories

You may want to take some of the following accessories with you when you travel:

- Spare batteries
- AC adapter and AC power cable
- Backup diskettes
- Appropriate printer driver files if you will be using a printer
- Cables for PC Cards (such as modem and network cards)
- Power adapters for foreign electrical outlets and modem cable adapters for foreign telephone networks
- CD-ROM drive
- DVD-ROM drive
- LS-120 drive
- CD-RW drive
- Diskette drive and parallel cable for using the drive as an external device
- Travel module

Traveling by Air

You may want to take the following precautions when you are traveling by air with your computer:

- Notify airport security in advance that you are bringing a portable computer.
- Be sure to have a charged battery or the AC adapter and power cable available in case you are asked to turn on the computer.
- Do not check the computer as baggage.

NOTICE: Have airport security personnel check the computer by hand. If the computer passes through a metal detector, data loss may occur. If you must pass the computer through a metal detector, first remove the hard-disk drive.

- Do not put the computer through a metal detector.

- The computer can go through an airport X-ray security machine.
 - Before you use the computer on an airplane, check the in-flight magazine or ask the flight crew to verify that such use is permitted. Some airlines forbid the use of electronic devices during the flight. All airlines forbid the use of electronic devices during takeoff and landing.
 - Dell has several carrying cases that protect the computer and accessories during travel.
 - If you pack the computer in a suitcase, do not pack so tightly that the computer display breaks or so loosely that the computer slides around.
 - Avoid packing the computer with items such as shaving cream, colognes, perfumes, or food.
 - Protect the computer, the battery, and the hard-disk drive from hazards such as extreme temperatures; overexposure to sunlight; and exposure to dirt, dust, or liquids.
 - Pack the computer so that it does not slide around in the trunk of your car or in an overhead storage compartment.
 - If you are carrying a second hard-disk drive separately, protect the drive from exposure to static electricity by placing the drive in an antistatic bag or wrapping it in a nonconductive fabric.
-

Travel Tips

- Consider changing the settings of your power management options to maximize battery life if you will be using battery power for extended periods.
- If you are traveling internationally, carry proof of ownership to speed your passage through customs. If the computer is provided by your employer, carry documentation of your right to use the computer. Investigate the customs regulations of the countries you plan to visit, and consider acquiring an international [carnet](#) from your government if you travel through many different countries.
- Power interruptions can occur frequently in some countries. Always have a charged battery available if traveling abroad.
- Credit card holders should check with their credit card companies for information about the kinds of emergency travel assistance they offer to users of portable computers. Many companies provide services that help you solve problems, such as quickly locating 3.5-inch diskettes or providing a direct-dial telephone line for your modem connection.

NOTICE: Do not use removable media drives while the computer is in motion. The vibrations could interrupt the flow of data to and from the storage devices and the hard-disk drive or diskette drive.

Carnet

A carnet is an international customs document (also known as a *merchandise passport*) that facilitates temporary imports into foreign countries and is valid for up to 1 year.

[Back to Contents Page](#)

[Back to Contents Page](#)

Drivers: Dell™ Latitude™ CPx H-Series/J-Series User's Guide

 [Installing Microsoft® Windows® 95 and Windows 98 Drivers](#)

 [Installing Microsoft® Windows NT® Drivers](#)

 [Installing Microsoft® Windows 2000 Drivers](#)







NOTE: For more information on using the operating system installed on your computer by Dell, see the operating system user's guide that came with your computer.

[Back to Contents Page](#)

[Back to Contents Page](#)

Customizing Your Computer: Dell™ Latitude™ CPx H-Series/J-Series User's Guide

-  [Using the System Setup Program](#)
-  [System Setup Options](#)
-  [Power Management Settings](#)
-  [Suspend-to-Disk Utility](#)

[Back to Contents Page](#)

Removing and Replacing Parts: Dell™ Latitude™ CPx H-Series/J-Series User's Guide

- [Installing a Primary Hard-Disk Drive](#)
 - [Preparing to Remove or Install Memory Modules](#)
 - [Removing or Installing Memory Modules](#)
-

Installing a Primary Hard-Disk Drive

NOTICE: To prevent data loss, turn off your computer before you remove the hard-disk drive. Do not remove the hard-disk drive if the computer is in suspend mode or if the drive access indicator is lit. Removing the drive under these conditions will lead to loss of data.

To install a primary hard-disk drive, perform the following steps:

1. Save any open files, turn off the computer, and remove any installed batteries.
2. Remove the hard-disk drive from the drive bay.

Close the display and turn the computer over. Using a small Phillips-head screwdriver, remove the screw (see Figure 1) that holds the drive carrier in the drive bay. Save the screw for use later in this procedure.

Figure 1. Removing a Hard-Disk Drive

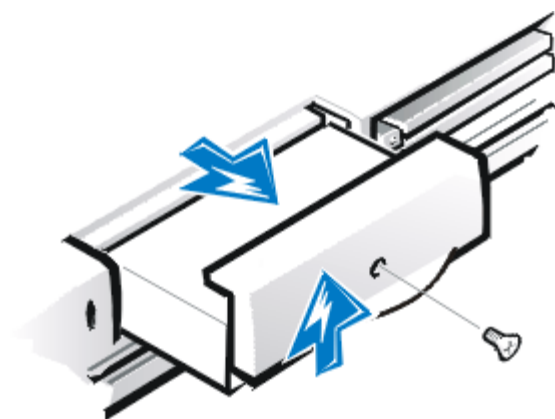

3. Gently pull the drive carrier out of the drive bay.

When the hard-disk drive is not in the computer, protect the drive from exposure to static electricity. See "Protecting Against Electrostatic Discharge" in your *System Information Guide* for more information.

4. Remove the new hard-disk drive from its packaging.

Save the original packaging to use when you store or ship the hard-disk drive.

5. Install the new hard-disk drive into the computer (it comes in a drive carrier).

NOTICE: If the drive carrier does not slide in easily, pull it out and try again. To avoid damage, do not force the drive carrier into the bay.

6. Gently push the drive carrier into the drive bay until the carrier door is flush with the computer case.
7. Replace the screw you removed in step 2. Be careful not to overtighten the screw.

If you have installed a new hard-disk drive, follow the directions that came with the drive to partition and logically format the drive and to create a suspend-to-disk (S2D) partition.

NOTICE: Hard-disk drives are extremely fragile and must be handled carefully to avoid damage. Follow these guidelines:

- **The primary hard-disk drive is installed in a metal carrier to protect the drive and make installation easier. When you remove and install hard-disk drives, handle the drive carrier, not the drive itself.**
- **Never press down on the top of the drive.**
- **Do not drop the drive. Even a slight jar or bump can damage the drive heads and spinning plates, thus rendering the drive inoperable.**



CAUTION: The primary hard-disk drive may be hot to the touch under extreme environmental conditions. If the drive is hot, allow it to cool before you replace it.

Preparing a New Primary Drive

Every primary hard-disk drive must be physically formatted, partitioned, and logically formatted before it can be used to store data. Every primary hard-disk drive from Dell is physically formatted before it is sent to you. Use the program(s) provided by your operating system to partition and logically format the hard-disk drive.

Preparing to Remove or Install Memory Modules

To prepare the computer for the removal or installation of memory modules, perform the following steps.



NOTES: If necessary, print these instructions for reference before proceeding.

NOTICE: Your portable computer does not support extended-data out (EDO) memory modules. Only synchronous dynamic random-access memory (SDRAM) modules are supported for use in Dell Latitude CPx H-Series/J-Series computers.

NOTICE: Do not install memory modules while the computer is in suspend, standby, or suspend-to-disk mode.

NOTICE: Ground yourself by touching an unpainted metal surface of a connector on the back of the

computer. While you work, periodically touch the connector to dissipate any static electricity that might harm internal components.

1. Turn off the computer and any attached peripherals, and disconnect them from their electrical outlets to reduce the potential for personal injury or shock.
 2. If the computer is docked, undock it.
 3. Disconnect the AC adapter and any attached peripherals, including telephone or telecommunication lines, from the computer.
 4. Remove the battery from the battery bay or the modular bay.
-

Removing or Installing Memory Modules

To remove or install memory modules, perform the following steps:

1. Close the display, and turn the computer upside down.
2. Remove the memory module cover.

Locate the small rectangular indentation at one end of the memory module cover. Place the tip of your finger under the cover by the indentation and firmly lift it up. When the door pops up, lift it up to remove it and expose the memory modules underneath it.

3. If you are replacing a memory module, remove the old one.

Carefully spread apart the inner metal tabs of the memory module socket just far enough for the memory module to disengage from the socket (it should pop up slightly). Then lift the memory module away from the socket (see Figure 2).

Figure 2. Removing a Memory Module

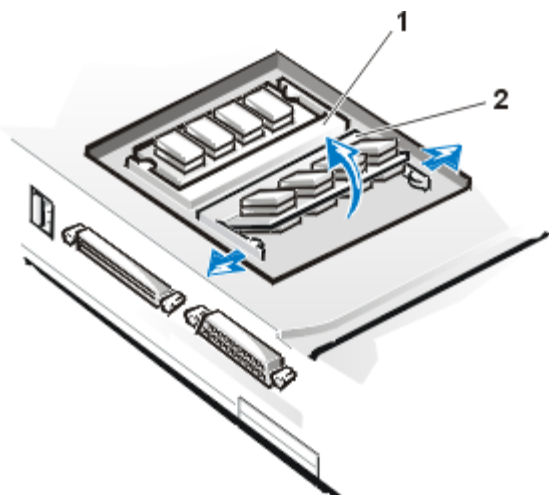

1 DIMM A

2 DIMM B

4. Ground yourself and unpack the new memory module from the upgrade kit.

5. Install the new memory module into the appropriate slot.



NOTES: If you are installing a 192-MB memory module, be sure that it is inserted with the double-stacked memory chips facing you. A 192-MB memory module inserted with the double-stacked memory chips facing down does not fit properly in the socket.

192-MB memory modules are designed for either the socket labeled DIMM A or the socket labeled DIMM B. They are not interchangeable.

The socket labeled DIMM A should be populated before the socket labeled DIMM B. If you only have one memory module, you should install it in the DIMM A socket. (See [Figure 2](#).)

Memory modules are *keyed*, or designed to fit into their sockets in only one direction. The slots on the system board are notched so that the memory module can be firmly seated only one way.

- a. Align the memory module's edge connector with the slot in the center of the memory module socket.
- b. With the module at a 45-degree angle, press the memory module's edge connector firmly into the memory module socket.
- c. Pivot the memory module down until it clicks into place.

If you do not hear a click as each end of the memory module snaps into the metal tabs, remove the memory module and reinstall it.

NOTICE: After installation, if the memory module cover does not fit or is difficult to close, you may have installed the memory module improperly into the wrong slots. Remove the memory modules and reinstall them. Do not force the memory module cover to close because you may damage your computer.

6. Replace the memory module cover as follows:

- a. Set the memory module cover loosely over the opening, making sure that the tabs on the bottom of the cover catch in the slots on either side of the opening.
- b. Slide the cover into place and press down on it until you hear it click.

7. Reconnect your computer and peripherals to their electrical outlets and turn them on.

As the computer boots, it detects the presence of additional memory and automatically updates the system configuration information.

8. In one of the following ways, verify that the **System Memory** option reflects the newly installed memory:

- Click the **Start** button, point to **Settings**, click **Control Panel**, and double-click the **System** icon. The amount of memory installed in the computer is displayed in the lower-right corner of the **General** tab window.
- In the System Setup program, the **System Memory** option appears in the lower-right corner of pages 1, 2, and 4.

To run the System Setup program, press <Fn><F1> on the computer's keyboard (or <Scroll Lock><F1> on an external keyboard if the **External Hot Key** option is enabled).

If the total amount of memory shown is incorrect, the memory module(s) may not be installed properly. Repeat [preparatory steps](#) 1 through 4 and [removal and installation](#) steps 1 through 8 until the memory total is correct.

9. Run the **System Memory** test of the [Dell Diagnostics](#) to confirm that all installed memory modules are operating correctly.
10. Use the [Suspend-to-Disk utility](#) to update the S2D partition on your hard-disk drive. The S2D partition stores system data while the computer is in suspend-to-disk mode.

[Back to Contents Page](#)

[Back to Contents Page](#)

Troubleshooting Your Computer: Dell™ Latitude™ CPx H-Series/J-Series User's Guide

 [Dell Diagnostics](#)

 [Error Messages and Flash Codes](#)

[Back to Contents Page](#)

Technical Specifications: Dell™ Latitude™ CPx H-Series/J-Series User's Guide

- [Processor](#)
- [Chip Set and Bus](#)
- [PC Cards](#)
- [Memory](#)
- [Connectors](#)
- [Audio](#)
- [Video](#)
- [14.1-Inch Display](#)
- [Keyboard](#)
- [Battery](#)
- [AC Adapter](#)
- [Physical](#)
- [Environmental \(Computer\)](#)
- [Touch Pad](#)
- [Track Stick](#)

Processor

| | |
|--------------------------------|--|
| Latitude CPx H-Series/J-Series | Intel® Mobile Pentium® III microprocessor. For J-Series, microprocessor includes Intel SpeedStep™ technology |
|--------------------------------|--|

Chip Set and Bus

| | |
|-------------------------------|---------------------------|
| System chip set | Intel Mobile 440BX AGPset |
| Microprocessor data bus width | 64 bits |
| DRAM bus width | 64 bits |
| Address bus width | 32 bits |
| Flash EPROM | 4 Mb |
| AGP bus | 66 MHz |
| PCI bus | 33 MHz |

PC Cards

| | |
|--------------------|---|
| CardBus controller | Texas Instruments PCI 1225 CardBus controller |
| PC Card connectors | two (supports type I and type II cards in any combination; type |

III cards can be used only in the lower connector; the lower connector supports zoomed video cards on systems using the Microsoft® Windows® 95 or Windows 98 operating system)

| | |
|------------------------|---------------|
| Cards supported | 3.3-V and 5-V |
| PC Card connector size | 68 pins |
| Data width (maximum): | |
| PCMCIA | 16 bits |
| CardBus | 32 bits |

Memory

| | |
|-----------------------------------|--|
| Architecture | SDRAM |
| Memory module sockets | two |
| Memory module capacities and type | 32-, 64-, 128-, 192-, and 256-MB 3.3-V SDRAM ¹ modules |
| Standard RAM | 32-MB memory module |
| Maximum RAM | 512 MB |
| Memory clock speed | 100 MHz |
| Memory access time | CL2 or CL3 (Note: CL3 indicates a CAS latency of 3 clocks) |
| BIOS address | F000:0000-F000:FFFF |

Connectors

| | |
|--------------|---|
| Serial (DTE) | 16,550-compatible, 16-byte buffer connector |
| Parallel | unidirectional, bidirectional, or ECP connector |
| Video | connector |
| PS/2 | mini-DIN connector |
| Infrared | port compatible with both IrDA Standard 1.1 (Fast IR) and IrDA Standard 1.0 (Slow IR) |
| Audio | microphone-in jack; line-in/audio-in jack; headphones/speakers jack |
| USB | USB-compliant connector |

| | |
|---------|---|
| Docking | connector for the C/Port Family Advanced Port Replicator or C/Dock Family Expansion Station |
| S-Video | 7-pin mini-DIN connector (an S-Video to composite video Adapter is also included with the computer) |

Audio

| | |
|----------------------------|---|
| Audio type | Sound Blaster (software emulation-capable) |
| Audio controller | For the H-Series, ESS Maestro 2E; for the J-Series, ESS Maestro 3I |
| Stereo conversion | 16 bit (analog-to-digital and digital-to-analog) |
| Interfaces: | |
| Internal | PCI bus/AC97 |
| External | stereo line-in minijack; microphone-in minijack; headphones/speakers-out minijack |
| Speakers | two 8-ohm speakers |
| Internal speaker amplifier | 1 W channel into 8 ohms stereo |
| Controls | volume can be controlled through key combinations, application program menus, or the Speaker window in the Dell Control Center (Windows 95 only) |

Video

| | |
|------------------|-----------------------------|
| Video type | 64-bit hardware-accelerated |
| Data bus | 2X AGP |
| Video controller | ATI Mobility M1 |
| Video memory | 8.0 MB |

14.1-Inch Display

| | |
|---------------------------|--------------------------------|
| Type | XGA, active-matrix color (TFT) |
| Dimensions (active area): | |
| Height | 214.3 mm (8.4 inches) |

| | |
|---------------------------|--|
| Width | 285.7 mm (11.3 inches) |
| Diagonal | 357.1 mm (14.1 inches) |
| Maximum resolution/colors | 1024 x 768; 24-bit color |
| Response time (typical) | 20 ms rise (maximum)/50 ms fall (maximum) |
| Operating angle | 0° (closed) to 180° |
| Viewing angles: | |
| Horizontal | ± 45° |
| Vertical | +15°/–30° |
| Dot pitch | 0.28 mm |
| Power consumption: | |
| Panel (typical) | 1.0 W |
| Backlight | 3.4 W |
| Controls | brightness can be controlled through a key combination |

Keyboard

| | |
|----------------|---|
| Number of keys | 87 (U.S., Canada, Korea, Thailand, and locations that use traditional Chinese); 88 (Europe); 90 (Japan) |
| Key travel | 2.8 mm ± 0.4 mm (0.11 inch ± 0.016 inch) |
| Key spacing | 19.05 mm ± 0.3 mm (0.75 inch ± 0.012 inch) |

Battery

| | |
|-------------|-----------------------|
| Type | lithium ion |
| Dimensions: | |
| Height | 21.5 mm (0.83 inch) |
| Depth | 88.5 mm (3.48 inches) |

| | |
|--|------------------------------|
| Width | 139.0 mm (5.47 inches) |
| Weight | 0.39 kg (0.87 lb) |
| Voltage | 14.8 VDC |
| Capacity | 53 WH |
| Charge time (approximate) ² : | |
| Computer on | 2.5 hours |
| Computer off | 1 hour |
| Life span (approximate) ² | 500 discharge/charge cycles |
| Temperature range: | |
| Charge | 0° to 35°C (32° to 95°F) |
| Storage | −40° to 65°C (−40° to 149°F) |

AC Adapter

| | |
|-------------------------|---|
| Input voltage | 90 to 135 VAC and 164 to 264 VAC |
| Input current (maximum) | 1.5 A |
| Input frequency | 47 to 63 Hz |
| Output current | 4.5 A (maximum at 4-second pulse); 3.51 A (continuous) |
| Rated output voltage | 20.0 VDC |
| Height | 27.94 mm (1.1 inches) |
| Width | 58.42 mm (2.3 inches) |
| Depth | 133.35 mm (5.25 inches) |
| Weight (with cables) | 0.4 kg (0.9 lb) |
| Temperature range: | |
| Operating | 0° to 40°C (32° to 104°F) |
| Storage | −40° to 65°C (−40° to 149°F) |

Physical

| | |
|------------------------|---|
| Height | 45.0 mm (1.77 inches) |
| Width | 319.0 mm (12.55 inches) |
| Depth | 252.5 mm (9.94 inches) |
| Weight ³ | |
| with 14.1-inch display | 2.73 kg (6.02 lb) with travel module installed in modular bay 2.93 kg (6.46 lb) with diskette drive installed in modular bay 3.06 kg (6.74 lb) with CD-ROM drive installed in modular bay |

Environmental (Computer)

Temperature:

| | |
|-----------|------------------------------|
| Operating | 0° to 35°C (32° to 95°F) |
| Storage | −40° to 65°C (−40° to 149°F) |

Relative humidity (maximum):

| | |
|-----------|----------------------------|
| Operating | 10% to 90% (noncondensing) |
| Storage | 5% to 95% (noncondensing) |

Maximum vibration:

| | |
|-----------|--|
| Operating | 0.9 GRMS using a random-vibration spectrum that simulates user environment |
| Storage | 1.3 GRMS using a random-vibration spectrum that simulates air/truck shipment |

Maximum shock⁴:

| | |
|-----------|--|
| Operating | 152.4 cm/sec (60.0 inches/sec) (equal to a half-sine pulse width of 2 ms) |
| Storage | 203.2 cm/sec (80 inches/sec) (equal to a half-sine pulse width of 2 ms) |

Altitude (maximum):

| | |
|-----------|--|
| Operating | −15.2 m to 3048 m (−50 to 10,000 ft) |
| Storage | −15.2 m to 10,668 m (−50 to 35,000 ft) |

Touch Pad

| | |
|---|--|
| Interface | PS/2-compatible |
| X/Y position resolution (graphics table mode) | 240 cpi |
| Size: | |
| Thickness | 2.8 mm (0.11 inch) at highest component |
| Width (sensor-active area) | 55mm (2.17 inch) |
| Height | 39-mm (1.54-inch) rectangle |
| Weight | 9.02 g (0.29 oz) |
| Power: | |
| Supply voltage | 5 V \pm .5 VDC |
| Supply current | 25 mA (maximum operating for track stick and touch pad combined) |
| ESD | In accordance with IEC-801-2 |

Track Stick

| | |
|-------------------------|--|
| Interface | PS/2-compatible |
| X/Y position resolution | 250 counts/sec. @100gf |
| Size: | Protrudes .5 mm higher than surrounding keycaps |
| Power: | |
| Supply voltage | 5 V \pm .5 VDC |
| Supply current | 25 mA (maximum operating for track stick and touch pad combined) |
| ESD | In accordance with IEC-801-2 |

NOTES:

The Dell Latitude CPx H-Series/J-Series does not support some memory modules from older models of Dell portable computers, such as the Latitude CP, XP, XPi CD, or LM. The H-Series only supports SDRAM modules and does not support EDO memory modules.

² Battery performance features such as charge time and life span can vary according to the conditions under which the computer and battery are used.

³ Weights are shown with a hard-disk drive, a battery in the battery bay, and a travel module, diskette drive, or a CD-ROM drive in the modular bay. Your computer might weigh more or less, depending on its configuration.

⁴ Measured with the hard-disk drive in head-parked position.

[Back to Contents Page](#)

[Back to Contents Page](#)

Getting Help: Dell™ Latitude™ CPx H-Series/J-Series User's Guide

 [Help Overview](#)

 [Contacting Dell](#)

[Back to Contents Page](#)

Modular Bay: Dell™ Latitude™ CPx H-Series/J-Series User's Guide

[Using the Modular Bay](#)

[Installing Devices in the Modular Bay With Softex Docking Services or Softex BayManager Software](#)

[Installing Devices in the Modular Bay Without Softex Docking Services or Softex BayManager Software](#)

Using the Modular Bay

Your computer comes with a diskette drive installed in the modular bay. You can also install a battery, a CD-ROM drive, a CD-RW drive, a DVD-ROM drive, a SuperDisk LS-120 drive module, or second hard-disk drive in the modular bay. To make the computer as light as possible, use the travel module in the modular bay in place of any of the available drives.

NOTICE: When the drives are not inside the computer, they are fragile and must be handled carefully to avoid damage. Do not press down on the drives or place heavy objects on top of them. Place the drives in a travel case to keep them free of dust and liquids. Store the drives in a safe place.

If your system is running Microsoft® Windows NT® with Softex Docking Services installed or if your system is running Windows® 95 or Windows 98 with Softex BayManager installed, see "[Installing Devices in the Modular Bay With Softex Docking Services or Softex BayManager Software](#)."

If your system does not have Softex Docking Services or Softex BayManager, see "[Installing Devices in the Modular Bay Without Softex Docking Services or Softex BayManager Software](#)."

If you are removing a device from the modular bay and installing a battery, see "[Batteries](#)."

If your system is running Windows 2000, device swapping in the modular bay is supported by the operating system. Although you can physically remove and install devices as described in the following subsections, refer to the information on unplugging or ejecting hardware in your Windows 2000 documentation instead of following the Softex- or System Setup-related steps in the following subsections.



NOTE: A new hard-disk drive must be formatted before you can use it. For instructions, see the documentation that came with the drive.

Installing Devices in the Modular Bay With Softex Docking Services or BayManager Software

Your computer may be using Windows 95 or Windows 98 with Softex BayManager software or Windows NT with Softex Docking Services software. This software allows you to hot-swap devices such as diskette drives, hard-disk drives, SuperDisk LS-120 drives, CD-ROM drives, CD-RW drives, and DVD-ROM drives to and from your computer's modular bay and the C/Dock Family Expansion Station's media bay. Hot-swapping capability allows you to remove and replace a device while the computer is on. You do not have to

shut down or restart the computer for the device to be recognized.

To install a device in the modular bay, perform the following steps:

1. Verify that the [Diskette Reconfig](#) option in the System Setup program is set to **Any Time**.
2. Verify that the [Display Close](#) option in the System Setup program is set to **Active**.
3. Save your work and close all open files and application programs.
4. If the computer is docked, undock it.
5. Double-click the **Docking Services** or **BayManager** icon in the Windows system tray on the task bar. The Softex BayManager window appears for Windows 95 or Windows 98, and the Docking Services window appears for Windows NT.
6. Click the **Remove/Swap** button.
7. If the modular bay contains a device, remove the device as follows:
 - a. Close the computer display and turn the computer over.
 - b. Slide the modular bay latch toward the Unlock icon.

Keep holding the modular bay latch with one hand while pulling the device out of the bay with the other hand.
 - c. After you remove the device, release the modular bay latch.
8. Slide the new device firmly into the modular bay.



*NOTE: Softex BayManager and Softex Docking Services do not report a second battery installed in the modular bay on the **Storage Devices** tab.*

9. Click **OK**. Then click **OK** again to close the Softex window.

For the latest information on Softex Docking Services, see the Softex user's guides at <http://www.dell.com/>. Click **Small Business Center** or **Medium & Large Business**. Click **Notebooks**; then, if applicable, click **Choose Latitude**. Look for *Softex Utilities Installation Guide* on the left of the screen.

If you are removing a device from the modular bay and installing a battery, see "[Batteries](#)."

Installing Devices in the Modular Bay Without Softex Docking Services or Softex BayManager Software

To install a device in the modular bay, perform the following steps:

1. Verify that the [Diskette Reconfig](#) option in the System Setup program is set to **Any Time**.

- Save your work and close all open files and application programs.
- 3. Turn your computer off.
- 4. If the computer is docked, undock it.
- 5. If the modular bay contains a device, remove the device as follows:
 - a. Close the computer display and turn the computer over.
 - b. Slide the modular bay latch toward the **Unlock** icon.

Keep holding the modular bay latch with one hand while pulling the device out of the bay with the other hand.

- c. After you remove the device, release the modular bay latch.
- Slide the new device firmly into the modular bay.

You should hear a click when the device is fully seated.

7. Dock the computer if necessary.
8. Turn on the computer.

[Back to Contents Page](#)

Using the System Setup Program: Dell™ Latitude™ CPx H-Series/J-Series User's Guide

 [Overview](#)

 [Entering the System Setup Program](#)

 [Using the System Setup Program](#)

Overview

Each time you turn on your computer, it compares the installed hardware with the system configuration information stored in nonvolatile random-access memory (NVRAM). If the system detects a discrepancy, it generates an error message for each incorrect configuration setting.

Power Management Compliance (APM Versus ACPI)

The system configuration process differs depending on the type of power management scheme used by the operating system. Microsoft® Windows® 95 and Windows NT use Advanced Power Management (APM). Windows 2000 uses Advanced Configuration and Power Management (ACPI). Windows 98 can be either APM- or ACPI-compliant, depending on the version you are using. If you have Windows 98, you can determine which power scheme you have by accessing the **System devices** list in the **Device Manager**.

For Windows 98 with *APM*, click **Start**—> **Settings**—> **Control Panel**—> **System**—> **Device Manager**—> **System devices**.

For Windows 98 with *ACPI*, click **Start**—> **Settings**—> **Control Panel**—> **System**—> **Hardware**—> **Device Manager**—> **System devices**.

Either APM or ACPI options will appear at the top of the **System devices** list.

- To adjust the configuration settings for APM operating systems, such as Microsoft Windows 95, Windows 98 with APM, or Windows NT®, you can use the System Setup program.
- ACPI operating systems, such as Windows 2000 and Windows 98 with ACPI, automatically configure most of the setup options available in the System Setup program. In such cases, the operating system overrides system setup options entered through the System Setup program. One exception is the **External Hot Key** option, which you can disable or enable only through the System Setup program. For more information on configuring features for these operating systems, see your Microsoft Windows Help.



NOTE: For ACPI operating systems, the System Setup program is accessible only during the system boot routine.

You can use the System Setup program as follows:

- To set or change user-selectable features — for example, your password or power management features
- To verify information about your computer's current configuration, such as the amount of system memory

For some setup options, you must reboot the computer before any changes take effect. Changes for other options take effect immediately.



*NOTE: If you change an option that is activated by rebooting, the System Setup program displays the setting you selected rather than the setting currently in effect. You **must** reboot for the new setting to take effect.*

After you set up your computer, run the System Setup program to familiarize yourself with your system configuration information and optional settings. Dell recommends that you write down the information for future reference.



*NOTE: If the computer uses the Microsoft Windows 95 operating system, you can also use the Dell Control Center to view and change the system configuration. Access the Dell Control Center from the **Dell Accessories** folder.*

For more information, see "[System Setup Options](#)."

Entering the System Setup Program

Enter and use the System Setup program as follows:

For APM operating systems, such as Windows 95, Windows 98 with APM, and Windows NT, press <Fn><F1> at any time on the keyboard (or <Scroll Lock><F1> on an external keyboard if the **External Hot Key** option is enabled). If you press <Fn><F3> (or <Scroll Lock><F3> on an external keyboard if the **External Hot Key** option is enabled), the System Setup program opens directly to the **Battery Status** screen.

For ACPI operating systems, such as Windows 2000 and Windows 98 with ACPI, you must enter System Setup before the operating system loads. Enter System Setup by pressing <F2> when the F2 message appears during the system boot routine.

Press <Esc> to exit the System Setup program. If you change the setting of an option that requires rebooting to take effect, exit the operating system *before* rebooting. (The Help text in the upper-right corner of System Setup screens 1, 2, and 4 tells you if the computer must be rebooted.)



NOTE: If the System Setup program is running when the computer enters suspend mode, the computer exits the System Setup program and then activates suspend mode.

For more information, see "[System Setup Options](#)."

Using the System Setup Program

The System Setup screens display the current setup and configuration information and optional settings for your computer. Information on the screens is organized in five boxed areas:

- **Title**

The box at the top of all screens lists the page number, system name, and version number of the basic input/output system (BIOS).

- **Options**

The box on the left half of screens 1, 2, and 4 lists options that define the installed hardware in your computer and the power conservation and security features for your computer.

Fields next to the options contain settings or values. You can change those values that appear bright on the screen. Options or values that you cannot change (because they are determined or calculated by the computer) appear less bright.

- **Help**

The box on the upper-right half of screens 1, 2, and 4 displays help information for the option with a currently highlighted field.

- **Computer data**

The box in the lower-right corner of screens 1, 2, and 4 displays information about your computer.

- **Key functions**

The line of boxes across the bottom of all screens lists keys and their functions within the System Setup program.

For more information, see "[System Setup Options](#)."

[Back to Contents Page](#)

Dell™ Diagnostics: Dell Latitude™ CPx H-Series/J-Series User's Guide

- [Overview](#)
- [Features of the Dell Diagnostics](#)
- [When to Use the Dell Diagnostics](#)
- [Starting the Dell Diagnostics](#)
- [Dell Diagnostics Main Screen Overview](#)
- [Confirming the System Configuration Information](#)
- [How to Use Dell Diagnostics](#)

Overview

Unlike many diagnostic programs, the Dell Diagnostics helps you check your computer's hardware without any additional equipment and without destroying any data. By using the diagnostics, you can have confidence in your computer's operation. And if you find a problem you cannot solve by yourself, the diagnostic tests can provide you with important information you will need when talking to Dell's service and support personnel.

NOTICE: Use the Dell Diagnostics to test only your Dell computer. Using this program with other computers may cause incorrect computer responses or result in error messages.

Features of the Dell Diagnostics

The Dell Diagnostics provides a series of menus and options from which you choose particular test groups or subtests. You can also control the sequence in which the tests are run. The diagnostic test groups or subtests also have these helpful features:

- **Options** that let you run tests individually or collectively
 - An option that allows you to choose the number of times a test group or subtest is repeated
 - The ability to display or print out test results, or to save them in a file
 - Options to temporarily suspend testing if an error is detected, or to terminate testing when an adjustable error limit is reached
 - A menu category called **Devices** that briefly describes each test and its parameters
 - A menu category called **Config** that describes the configuration of the devices in the selected device group
 - Status messages that inform you whether test groups or subtests were completed successfully
 - Error messages that appear if any problems are detected
-

When to Use the Dell Diagnostics

Whenever a major component or device in your computer does not function properly, you may have a component failure. As long as the microprocessor and the input and output components of your computer (the display, keyboard, and diskette drive) are working, you can use the Dell Diagnostics. If you are experienced with computers and know what component(s) you need to test, simply select the appropriate diagnostic test group(s) or subtest(s). If you are unsure about how to begin diagnosing a problem, read the rest of this section.

Starting the Dell Diagnostics

Perform the following steps to start the diagnostics:

1. Turn off the computer.
2. Undock the computer if you have it docked.
3. Turn on the computer.
4. Press <F2> at the Dell BIOS splash screen to access the System Setup menu.
5. Select the following boot sequence:
 - Boot First Device: Diskette Drive
 - Boot Second Device: CDROM / DVDROM Drive
 - Boot Third Device: Internal HDD
6. Insert the Dell *System Software* CD into the CD-ROM drive.
7. Turn the computer off.
8. Turn the computer on. The system restarts and automatically begins to run the Dell Diagnostics.
9. When you have completed running diagnostics, remove the Dell *System Software* CD from the CD-ROM drive.

To change the boot sequence, repeat steps 1 through 5, customizing the boot sequence to fit your needs. Then restart your system.



NOTE: Before you read the rest of this subsection, you may want to start the Dell Diagnostics so that you can see it on your display.

When you start the diagnostics, the Dell logo screen appears, followed by a message telling you that the diagnostics is loading.

After the diagnostics loads, the **Diagnostics Menu** appears (see [Figure 1](#)). The menu allows you to run all or specific diagnostic tests or to exit to the MS-DOS prompt.

For a quick check of your computer, select the **Quickly Test All Devices** option. This option runs only the subtests that do not require user interaction and that do not take a long time to run. Dell recommends that you choose this option first to increase the odds of tracing the source of the problem quickly. For a thorough check of your computer, select the **Fully Test All Devices** option. To check a particular area of your computer, select the **Select Devices to Test** option.

To select an option from this menu, highlight the option and press <Enter>, or press the key that corresponds to the highlighted letter in the option you choose.

Figure 1. Diagnostics Menu

Fully Test All Devices

Quickly Test All Devices

Select Devices to Test

Exit to MS-DOS

Dell Diagnostics Main Screen Overview

When you select **Select Devices to Test** from the **Diagnostics Menu**, the main screen of the diagnostics appears (see [Figure 2](#)). The main screen lists the diagnostic test device groups, lists the devices of the selected device group, and allows you to select categories from a menu. From this screen, you can enter two other types of screens.

Information on the main screen of the diagnostics is presented in the following five areas:

- Two lines at the top of the screen identify the version number of the Dell Diagnostics.
- On the left side of the screen, the **Device Groups** area lists the diagnostic test groups in the order they will run if you select **All** from the **Run tests** menu category. Press the up- or down-arrow key to highlight a test device group.
- On the right side of the screen, the **Devices for Highlighted Group** area lists the computer's currently detected hardware and some of the relevant settings.
- The lower-right side of the screen displays information about your integrated drive electronics (IDE) hard-disk and CD-ROM drive(s).
- Two lines at the bottom of the screen make up the menu area. The first line lists the categories you can select; press the left- or right-arrow key to highlight a menu category. The second line gives information about the category currently highlighted.



NOTE: The options displayed on your screen should reflect the hardware configuration of your computer.

Figure 2. Dell Diagnostics Main Screen

Dell Computer Corporation
Diagnostics Version 2.00

Device Groups

System Board Devices
Processor Cache
IR
System Memory
Latitude Battery
Latitude Fan
Latitude Temperature
System Management BIOS
VESA/VGA Interface
Universal Serial Bus Interface
PC-AT Compatible Keyboards
Pointing Devices
Serial Ports
Parallel Ports
Audio Controller
IDE Devices
Misc. PCI Devices

Devices for Highlighted Group

DMA Controller
Realtime Clock
System Timer
Interrupt Controller
System Speaker
Floating Point Unit

Device groups: Run tests Devices Select Config Help

Display the Run tests menu.

Press ESC for previous menu.

Confirming the System Configuration Information

When you boot your computer from your diagnostics diskette, the diagnostics checks your system configuration information and displays it in the **Device Groups** area on the main screen.

The following sources supply this configuration information for the diagnostics:

- The system configuration information settings (stored in nonvolatile random-access memory [NVRAM]) that you selected while using the System Setup program
- Identification tests of the microprocessor, the video controller, the keyboard controller, and other key components
- Basic input/output system (BIOS) configuration information temporarily saved in RAM

Do not be concerned if the **Device Groups** area does not list the names of all the components or devices you know are part of your computer. For example, you may not see a printer listed, although you know one is attached to your computer. Instead, the printer is listed as a parallel port. The computer recognizes the parallel port as LPT1, which is an address that tells the computer where to send outgoing information and where to look for incoming information. Because your printer is a parallel communications device, the computer recognizes the printer by its LPT1 address and identifies it as a parallel port. You can test your printer connection in the **Parallel Ports** tests.

How to Use Dell Diagnostics

Six comprehensive, menu-driven, online Help categories provide instructions on how to use the program and explain

each menu item, test group, subtest, and test and error result. To enter the **Help** menu, perform the following steps:

1. Highlight **Select Devices to Test** in the **Diagnostics Menu**.
2. Press <Enter>.
3. Press <h>.

The six **Help** menu categories are [Menu](#), [Keys](#), [Device Group](#), [Device](#), [Test](#), and [Versions](#). The online Help also provides detailed descriptions of the devices that you are testing. The **Help** categories are explained below.

Menu Category

The **Menu** Help category provides descriptions of the main menu screen area, the **Device Groups**, and the different diagnostic menus and commands and instructions on how to use them.

Keys Category

The **Keys** Help category explains the functions of the all of the keystrokes that can be used in Dell Diagnostics.

Device Group Category

The **Device Group** Help category describes the test group that is presently highlighted in the **Device Groups** list on the main menu screen. It also provides reasoning for using some tests.

Device Category

The **Device** Help category is the educational section of online Help. It describes the function and purpose of the highlighted device in the **Device Groups**. For example, the following information appears when you select the **Device** Help category for **Diskette** in the **Device Groups** list:

Diskette drive A:

The diskette disk drive device reads and writes data to and from diskettes. Diskettes are flexible recording media, sometimes contained in hard shells. Diskette recording capacities are small and access times are slow relative to hard disk drives, but they provide a convenient means of storing and transferring data.

Test Category

The **Test** Help category provides a thorough explanation of the test procedure of each presently highlighted test group subtest. An example of the **Diskette** subtest **Diskette Drive Seek Test** is as follows:

Diskette drive A: - Diskette Drive Seek Test

This test verifies the drive's ability to position its read/write heads. The test operates in two passes: first, seeking from the beginning to ending cylinders inclusively, and second, seeking alternately from the beginning to ending cylinders with convergence towards the middle.

Versions Category

The **Versions** Help category lists the version numbers of the subtests that are used by the Dell Diagnostics.

AC Adapter: Dell™ Latitude™ CPx H-Series/J-Series User's Guide

[Using the AC Adapter](#)

[Connecting the AC Adapter](#)

[Turning the Computer On](#)

Using the AC Adapter

The AC adapter converts AC power to the DC power required by the computer. The AC adapter kit includes two cables: the AC adapter cable and an AC power cable.

You can connect the AC adapter with your computer either turned on or off.

The AC adapter works with electrical outlets worldwide. However, power connectors vary among countries. Before you use AC power in a foreign country, you may need to obtain a new power cable adapter designed for use in that country.

If the computer is docked to one of Dell's C/Port Family Advanced Port Replicators (APR) or C/Dock Family Expansion Stations, you can run the computer on AC power by connecting the AC adapter to the C/Port APR or C/Dock Expansion Station.



NOTE: If you are running your computer on AC power with a battery installed, the AC adapter charges the battery (if needed) and then maintains the battery's charge.

NOTICE: To avoid overheating, the AC adapter should be in a ventilated area, such as on a desktop or on the floor, when used to power the computer or charge the battery. Do not use the AC adapter in a poorly ventilated environment, such as inside a carrying case.

Connecting the AC Adapter

To connect the AC adapter, perform the following steps:

1. Connect the AC adapter power cable to the AC adapter (See [Figure 1](#)).
2. Plug the AC adapter power cable into an electrical outlet.
3. Plug the AC adapter cable into the AC adapter connector on the computer.

Figure 1. Connecting the AC Adapter

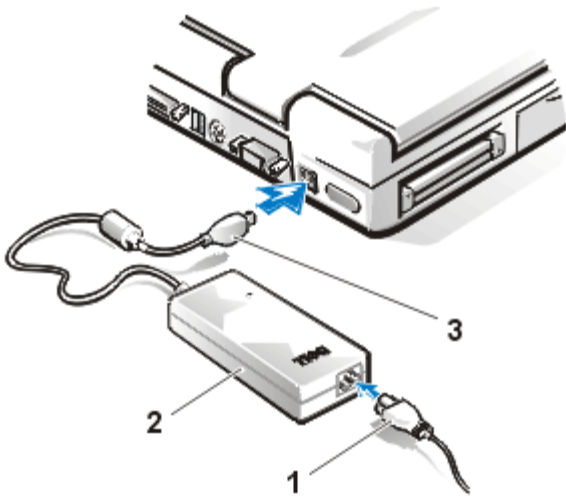

- 1 AC adapter power cable
 - 2 AC adapter
 - 3 AC adapter cable
-

Turning the Computer On

To turn on the computer, press the power button. (See [Figure 1](#) in "Introduction.")



NOTE: If your computer's operating system is "locked up"—that is, it does not respond to commands—press and hold down the power button for at least five seconds to shut it off.

[Back to Contents Page](#)

PC Cards: Dell™ Latitude™ CPx H-Series/J-Series User's Guide

[About PC Cards](#)

[Removing PC Cards](#)

[Installing PC Cards](#)

[Configuring PC Cards](#)

About PC Cards

The computer has a slot into which you can install up to two PC Cards if the PC Cards comply with Release 2.01 of the Personal Computer Memory Card International Association (PCMCIA) standard and Release 4.2 of the Japanese Electronic Industry Development Association (JEIDA) standard.

The computer supports type I, type II, and type III PC Cards (including memory cards) and advanced technology attachment (ATA) cards that emulate integrated drive electronics (IDE) hard-disk drives. Also supported are input/output (I/O) cards such as modems, local area network (LAN) cards, wireless LAN cards, and small computer system interface (SCSI) cards.

If you are using the Microsoft® Windows® 95, Windows 98, or Windows 2000 operating system, you can use a zoomed video (ZV) PC Card only in the lower PC Card connector. (The Microsoft Windows NT® 4.0 operating system does not support ZV.)



NOTES: A PC Card is not a boot device. The "type" of a card refers to its thickness, not its functionality.

Your computer recognizes most I/O cards and automatically loads the device driver associated with that card.

NOTICE: Take extra precautions if you use extended PC Cards in your computer. Extended cards are longer versions of standard PC Cards. They fit into, and operate correctly with, your computer. However, they extend beyond the edge of the computer when installed. If something strikes the exposed end of an installed card, your system board can be damaged. Because of space considerations, you may have trouble using two PC Cards in your computer if one of them is an extended card. It may be easier to use an extended card if you install it in the upper PC Card connector. Always remove an extended PC Card before you pack the computer in its carrying case.

Installing PC Cards

You can use the following PC Card combinations in the PC Card slots:

- A single type I or type II card (using either the upper or lower PC Card connector)
- A single type III card (using the lower PC Card connector only)
- One type I card and one type II card (using either connector)
- Two type I cards or two type II cards

 *Note: Use a ZV PC Card in the lower connector only.*

PC Cards are generally marked with a symbol, such as a triangle or an arrow, to indicate which end should be inserted into the slot. The cards are keyed to prevent incorrect insertion. If card orientation is not clear, see the documentation that came with the card.

You do not need to turn off your computer or exit suspend or standby mode before you install a PC Card. To install a PC Card (see [Figure 1](#)), perform the following steps:

1. If necessary, remove the blank from the PC Card connector you intend to use by pressing the eject button and pulling the blank out.
2. Hold the card with its orientation symbol pointing into the slot and the top side of the card facing up.
3. Insert the card into the slot, and press in firmly until the card is completely seated in the internal PC Card connector.
4. If you encounter too much resistance when inserting it, do not force the card. Check the card's orientation and try again.

Figure 1. Installing a PC Card

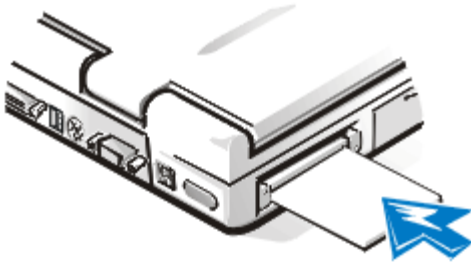

PC Card Blanks

Save the blank to use whenever you do not have a PC Card installed. The blank protects the PC Card connector from dust and other particles.

Removing PC Cards

NOTICE: If you are using Windows 95, Windows 98, or Windows 2000, use the PC Card configuration utility on the taskbar to select and stop a card before you remove it. If you do not remove the card in the configuration utility, you could lose data from open application programs.

To remove a PC Card (see [Figure 2](#)), perform the following steps:

1. Stop the PC Card using the PC Card configurations utility on the taskbar.
2. Press the PC Card eject button.

The PC Card or blank protrudes from the slot slightly. It does not come out all the way.

3. Gently remove the card.

Figure 2. Removing a PC Card

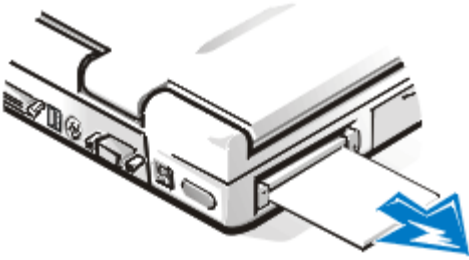

To protect the PC Card connectors, install a blank if you are not going to use the connector.

Configuring PC Cards

The PC Card configuration utility performs the following functions:

- Notifies you whenever a PC Card is inserted and tells you how the card is configured
- Automatically loads the proper device driver if it is available on the hard-disk drive
- If drivers are not available on the hard-disk drive, prompts you to install them using the device driver diskette that came with the card

The operating system automatically detects a PC Card and opens the **Add New Hardware** menu from the **Control Panel**. For more information, see the PC Card operating system documentation.

[Back to Contents Page](#)

Batteries: Dell™ Latitude™ CPx H-Series/J-Series User's Guide

- [About the Batteries](#)
- [Charging a Hot Battery](#)
- [Battery Usage](#)
- [Installing a Battery in the Battery Bay](#)
- [Installing a Second Battery](#)
- [Battery Charge Gauge](#)
- [First Low-Battery Warning](#)
- [Second Low-Battery Warning](#)
- [Charging the Battery](#)
- [Detecting Battery Problems](#)
- [Battery Disposal](#)
- [About Battery Power](#)
- [Turning the Computer On](#)

About the Batteries

Your computer's lithium ion battery provides power when an electrical outlet is not available. A battery in the battery bay is standard with the computer. Lithium ion batteries are longer lived than conventional batteries and do not require replacement as often. To double battery life, install a second battery in the modular bay. Lithium ion batteries do not have the "memory effect" that is exhibited by nickel-metal hydride (NiMH) and nickel-cadmium (NiCD) batteries. You do not need to drain a lithium ion battery completely before recharging it. A lithium ion battery will not "forget" at which point it is fully charged. NiMH and NiCD batteries may not charge fully if they are partially drained then recharged.

The lithium ion technology used in your computer's battery is significantly less hazardous to the environment than the lithium metal technology used in some other batteries (such as watch batteries). Spent batteries should not be placed with common household waste products. Contact local authorities for the location of a chemical waste collection program nearest you.

Keep the following information in mind when you are running your computer from the battery:

- You can expect 2.5 to 5 hours of battery life with a single fully charged battery and 6 to 10 hours of battery life with two fully charged batteries. Actual performance varies, depending on which power management features are enabled and which application programs are being used.
- When two batteries are installed, the AC adapter first charges the battery in the battery bay.
- The integrated [charge gauge](#) lets you check a battery's charge before you insert it into the computer.
- The battery's self-test capability alerts you to battery conditions such as low charge.
- There is no battery memory effect with lithium ion batteries—you can charge the battery whenever you like without fear of reducing its charge capacity.
- A battery has a life span of up to 500 full charges and 2000 partial charges, provided it is charged at normal room temperature.

Charging a Hot Battery

If your battery is hot from being used in your computer or being in a hot environment, take note of the following precautions:

- A hot battery will not charge when you connect the AC adapter to the computer. This safety feature is important because charging a hot battery shortens the battery's life span and may damage the battery and the computer.
 - The battery is too hot to start charging if the battery indicator flashes alternately green and amber. If this occurs, disconnect the computer from its electrical outlet and allow it and the battery to return to room temperature. Reconnect the computer to the electrical outlet and continue charging the battery.
 - If the computer is not allowed to return to room temperature, the battery stops charging before it reaches its full capacity.
-

Battery Usage

The battery is partially charged when you receive it. Dell recommends that you charge your battery to full capacity before using it to power the computer.

If you are powering the computer from a battery, try to conserve battery power. A number of factors affect battery operating time:

- Power conservation features that you use
- Type of display and microprocessor your computer has
- Use of the optical or storage drive modules
- Number and type of PC Cards and other external devices you use
- Kinds of application programs you run
- Capacity of the memory modules you install (the higher the capacity, the more power used)
- Use of the infrared port

When you activate suspend mode (known as [standby](#) in the Microsoft® Windows® 98 operating system), the computer can run on battery power for approximately one week (if the battery was fully charged before activating suspend or standby mode).

If you are going to store the computer, disconnect all peripheral devices and turn off the computer. Remove the battery when you store your computer for an extended period of time. A battery will drain when not in use during prolonged storage. After a long storage period, recharge the battery fully before you attempt to run your computer from battery power.

Installing a Battery in the Battery Bay

NOTICE: To avoid data loss, do not replace a battery while the computer is turned on unless the computer is connected to an electrical outlet or a second battery is installed.

To install a battery in the battery bay, perform the following steps (see [Figure 1](#)).

 **NOTES:** You can also install a battery in the modular bay.

If necessary, print these instructions for reference before proceeding.

Figure 1. Installing a Battery

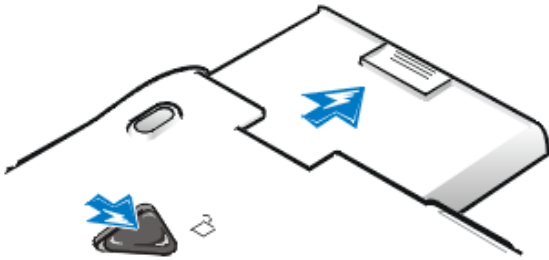

1. Save your work and close all open files and application programs.
2. If the computer is docked, undock it.
3. If the modular bay contains a battery, go to step 5.
4. If the only battery in the computer is in the battery bay and that is the battery you want to replace, connect the computer to an electrical outlet *or* preserve your data in one of these ways:
 - Use suspend mode.

Place the computer in suspend mode by pressing <Fn><Esc> (or <Scroll Lock><Esc> on an external keyboard if the **External Hot Key** option is enabled in the System Setup program). Then shut down the computer.
 - Use suspend-to-disk mode.

Place the computer in suspend-to-disk mode by pressing <Fn><a> (or <Fn><q> on a French keyboard). When the green power indicator turns off, continue.
5. Remove the battery from the battery bay.
 - a. Close the computer display and turn the computer over.
 - b. Slide the battery bay latch toward the **Unlock** icon. Hold the latch with one hand while pulling the battery out of the bay with the other hand.
 - c. Release the latch after you remove the battery.
6. Slide the new battery firmly into the battery bay. You should hear a click when the battery is fully seated.
7. If you put the computer into suspend or suspend-to-disk mode, press the power button to resume normal operation.

Installing a Second Battery

NOTICE: To avoid data loss, do not replace a battery while the computer is turned on unless the computer is connected to an electrical outlet or a second battery is installed.

 *NOTE: The following procedure applies only if you are replacing a storage module that has been operating in the modular bay. If you are installing a battery into an empty modular bay, you can hot-swap the battery (insert the battery while the computer is on).*

1. Save your work and close all open files and application programs.
2. If the computer is docked, undock it.

3. If your system does not have Softex Docking Services or Softex BayManager, go to step 5.
4. If your system is running Microsoft Windows NT® with Softex Docking Services installed or if your system is running Windows 95 or Windows 98 with Softex BayManager installed, perform the following steps.
 - a. Double-click the **Docking Services** or **BayManager** icon in the Windows system tray on the task bar. The Softex BayManager window appears for Windows 95 or Windows 98. The Docking Services window appears for Windows NT.
 - b. Click the **Remove/Swap** button.
5. If BayManager is not installed, preserve your data in one of these ways and then go to step 6:
 - Use the suspend mode.

Place the computer in suspend mode by pressing <Fn><Esc> (or <Scroll Lock><Esc> on an external keyboard if the **External Hot Key** option is enabled in the System Setup program).
 - Use the suspend-to-disk mode.

Place the computer in suspend-to-disk mode by pressing <Fn><a> (or <Fn><q> on a French keyboard). When the green power indicator turns off, continue.
6. Remove any device that may be installed in the modular bay (see [Figure 2](#)).
 - a. Close the computer display and turn the computer over.
 - b. Slide the modular bay latch toward the **Unlock** icon to release the device in the bay. Hold the latch in the unlock position while pulling the device out of the bay.
 - c. Release the latch after you remove the device.

Figure 2. Removing a Device from the Modular Bay

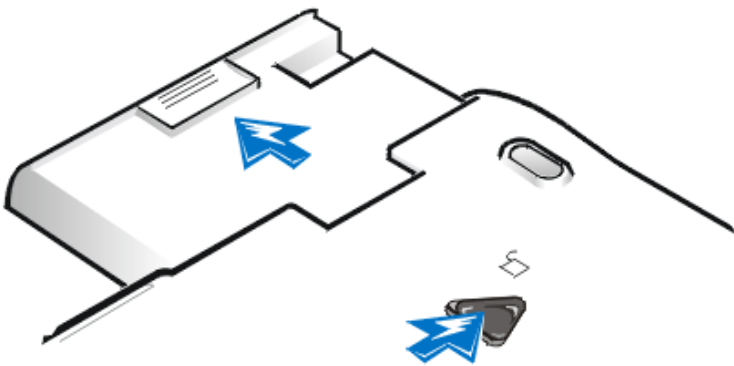

7. Slide the new battery firmly into the battery bay. You should hear a click when the battery is fully seated.



*NOTE: Softex BayManager and Docking Services do not report a second battery installed in the modular bay on the **Storage Devices** tab.*

8. If your system is running Microsoft Windows NT with Softex Docking Services or Windows 95 or Windows 98 with Softex BayManager, click **OK**. Then click **OK** to close the Softex window.

9. If you put the computer into suspend or suspend-to-disk mode, press the power button to resume normal operation.

Battery Charge Gauge

The battery charge gauge consists of five indicators. Each indicator represents 20 percent of full charge. If only one indicator lights up, recharge the battery before using it.

To check the charge level, press the battery test button that is next to the indicators (see [Figure 3](#)). The appropriate number of indicators lights up for a few seconds to indicate the amount of charge remaining in the battery. For example, if three indicators light up, your battery has between 41 percent and 60 percent of its charge left.

Figure 3. Battery Charge Gauge

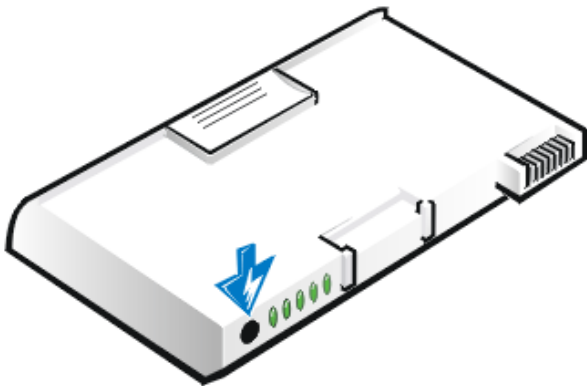

NOTES: An indicator that blinks rapidly when you check the battery's charge level indicates a temporary failure or a potentially recoverable failure like overheating. Allow the battery to cool for several minutes before checking the charge level again.

If the battery is experiencing a permanent failure, when you press the battery test button, you will see no indicators. If you install such a battery into the computer, the amber battery indicator on the computer flashes rapidly. To purchase a new battery, [call Dell](http://www.dell.com) or access the Dell World Wide Web site at <http://www.dell.com>. Dispose of the old battery properly.

Percentage of Charge

When you press the battery test button, the number of indicators that light up shows an estimate of the remaining battery charge:

- If one indicator lights up, the battery has 1 to 20 percent of its charge remaining.
- If two indicators light up, the battery has 21 to 40 percent of its charge remaining.
- If three indicators light up, the battery has 41 to 60 percent of its charge remaining.
- If four indicators light up, the battery has 61 to 80 percent of its charge remaining.
- If five indicators light up, the battery has 81 to 100 percent of its charge remaining.

First Low-Battery Warning

The first low-battery warning—a blinking amber battery indicator—occurs when you have about 15 minutes of battery life left under current conditions and the computer is not connected to an electrical outlet. Figure 4 shows the battery indicator status lights.

Figure 4. Status Lights

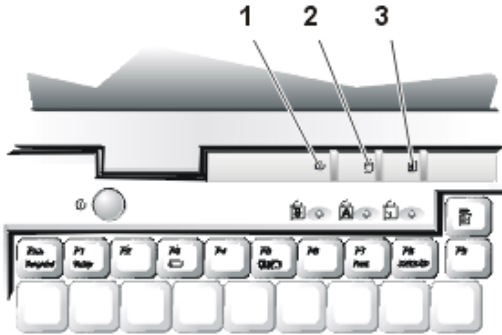

- 1 Power indicator
- 2 Drive access indicator
- 3 Battery indicator

NOTICE: When you see a low-battery warning, save your work immediately. Then replace the battery or connect your computer to an electrical outlet.

After the first low-battery warning, if no input/output (I/O) activity occurs within 75 seconds, the computer activates suspend-to-disk mode. If the computer has no suspend-to-disk partition, the computer enters suspend mode. The computer can preserve data for several hours in suspend mode.

If you have set the computer to enter suspend-to-disk mode after a certain amount of time with no I/O activity, the computer enters suspend-to-disk mode before the final low-battery warning. Once suspend-to-disk mode is activated, no further power is consumed.

NOTICE: Never turn off the computer while the drive access indicator is on. Doing so could cause data loss. Instead, close all of your application programs before you turn off the computer.

Second Low-Battery Warning

The second low-battery warning—a steady amber battery indicator—occurs when you have about 5 minutes of battery life left under current conditions and the computer is not connected to an electrical outlet.

After the second low-battery warning, if no further I/O activity occurs within 15 seconds, the computer activates suspend-to-disk mode. If there is no suspend-to-disk partition, the computer enters suspend mode. The computer can preserve data for several hours in suspend mode.

If the computer is already in suspend mode when a final low-battery warning occurs, the computer activates suspend-to-disk mode immediately. If suspend-to-disk mode has been disabled, the computer reenters suspend mode.

NOTICE: To avoid losing data (and possibly corrupting data areas on your hard-disk drive), save your work immediately after a second low-battery warning. Then connect your computer to an electrical outlet, or place the computer in suspend mode. If the battery runs completely out of power, the computer shuts off without properly closing any open files.

Charging the Battery

Each time you connect the computer to an electrical outlet or install a battery in a computer that is connected to an electrical outlet, the computer checks the battery's charge. The AC adapter charges the battery (if needed) and then maintains the battery's charge.

 **NOTE:** For maximum battery performance, charge the battery only at normal room temperature.

If two batteries are installed in the computer, the AC adapter first charges the battery in the battery bay, then the battery in the modular bay.

When installed in a computer connected to an electrical outlet, the battery immediately starts charging. The green power indicator remains steady while the AC adapter charges the battery. The indicator starts blinking when the express charge cycle is complete. While the indicator is blinking, the AC adapter provides a trickle charge to bring the battery to full capacity. The indicator continues to blink until you remove the battery or disconnect the computer from its electrical outlet.

NOTICE: If the battery indicator flashes alternately green and amber while the computer is connected to an electrical outlet, disconnect the computer from the outlet and allow the computer and the battery to return to room temperature. Then reconnect the computer to its electrical outlet and continue charging the battery. If the computer is not allowed to return to room temperature, the battery stops charging before it reaches full capacity.

If the computer is turned off and connected to an electrical outlet through the AC adapter, it takes the AC adapter about 1 hour to fully charge a battery that has been completely discharged. If the computer determines that the battery is near full capacity, the AC adapter skips the express-charging process and starts trickle-charging the battery. If the computer is on, it takes up to 2.5 hours to charge a fully discharged battery, depending on which devices you are using and which programs you are running.

 **NOTE:** You can leave the battery in the computer as long as you like. The battery's integrated circuitry prevents the battery from overcharging.

Detecting Battery Problems

A battery problem may prevent the battery from being charged to its full potential and can lead to unpredictable operation. To obtain a new battery, [call Dell](http://www.dell.com) or access the Dell World Wide Web site at <http://www.dell.com>.

Dell suggests you follow these precautions when using the battery:

- To avoid installing a defective battery in your computer, first check the battery's charge, indicated by the battery charge indicators on the battery itself, by pressing the battery test button ([see Figure 3](#)).

 **NOTE:** If the battery has a 0 (zero) percent charge, you cannot use the battery test button to check the battery's capacity. The battery gauge indicator will not light if the battery is completely drained.

- If, after you insert the battery in the computer, the computer's battery indicator status light ([see Figure 4](#)) flashes alternately green and amber, the battery is too hot to charge. Turn off the computer, and let the battery and computer cool to room temperature.
- If, after you insert the battery in the computer, the computer's battery indicator status light ([see Figure 4](#)) flashes amber for 4 seconds when you connect or disconnect the AC adapter or when you press the power button, you

need to replace the battery.

- If, after you insert the battery in the computer, the computer's battery indicator status light ([see Figure 4](#)) flashes rapidly amber, the battery is defective and needs to be replaced.

Battery Disposal

When your battery no longer holds a charge, call your local waste disposal agency or environmental agency for advice on disposing the computer's lithium ion battery.

 **CAUTION: Do not puncture or incinerate the battery.**

 **NOTES:** *The lithium ion technology used in your computer's battery is significantly less hazardous to the environment than the lithium metal technology used in some other batteries (such as watch batteries).*

This computer is supplied with a lithium ion battery. Lithium ion batteries are longer lived than conventional batteries and do not require replacement as often. Spent batteries should not be placed in common household waste products. Contact local authorities for the location of a chemical waste collection program nearest you. To purchase a new battery, [call Dell](#) or access the Dell World Wide Web site at <http://www.dell.com>.

About Battery Power

You automatically conserve battery power each time you attach the computer to an electrical outlet. The battery is even being recharged when you use AC power. The battery's life expectancy is largely determined by the number of charges it receives, so use an electrical outlet to run the computer whenever possible.

You can customize power management by individually controlling the computer's power conservation features. These features reduce power consumption by monitoring application programs and computer devices for inactivity and slowing down or stopping some of the computer's internal devices.

 **NOTES:** *When you use power conservation features, you often trade some of the performance of the computer for increased battery operating time. For example, if you turn off the hard-disk drive, you may experience a delay the next time the computer tries to access the hard-disk drive.*

Other power conservation features, such as suspend mode, stop almost all system activity. They allow you to maximize power conservation when your work is interrupted.

Experiment with power conservation features to achieve the optimum power conservation for your work environment.

Turning the Computer On

To turn on the computer, press the power button (See [Introduction](#)).

 **NOTE:** *If your computer's operating system is "locked up"—that is, it does not respond to commands—press and hold down the power button for at least five seconds to shut it off.*

[Back to Contents Page](#)

CD-ROM, DVD-ROM, and CD-RW Drives: Dell™ Latitude™ CPx H-Series/J-Series User's Guide

[Using the CD-ROM and DVD-ROM Drives](#)

[Caring for CDs, DVDs, and CD-RW Discs](#)

[Types of Supported Discs](#)

Using the Drives

The DVD-ROM and CD-ROM drives are read-only devices that let you play most commercially available 8- or 12-centimeter (cm) sound and video CDs on the computer. In addition to playing most CDs, the DVD-ROM drive can also play DVDs. CD-rewritable (CD-RW) drives can write to and play CD-RWs and can play CDs. Dell installed the appropriate CD-ROM drive device drivers on your hard-disk drive.

Use the DVD-ROM, CD-ROM, or CD-RW drive in the computer's modular bay or the modular bay in a C/Port Family Advanced Port Replicator (APR) or a C/Dock Family Expansion Station. None of these drives can be used externally without an APR or an Expansion Station. You must turn the computer off before installing the drive in the modular bay. For detailed instructions on installing devices in the modular bay, see "[Using the Modular Bay](#)."

Figure 1. DVD-ROM, CD-ROM, or CD-RW Drive Installed in Computer



NOTICE: Protect the DVD-ROM and CD-ROM drives when they are not in the modular bay. Do not squeeze the drive or place objects on top of it; doing so could damage the drive motor. Keep the drive as clean as possible.

NOTICE: Always use compressed air to clean the lens in the drive. Never touch the lens.

NOTICE: If the CD or DVD is not seated correctly, the drive can be damaged.

To play a CD, press the eject button on the face of the CD-ROM or DVD-ROM drive or press <Fn><F10>. When the tray slides out, place the CD into the tray label side up. Make sure that the CD is seated correctly on the spindle by pressing down on the disc until it clicks in place. Then gently push in the tray.

To play a DVD, press the eject button on the face of the DVD-ROM drive or press <Fn><F10>. When the

tray slides out, place the DVD into the tray label side up. Make sure that the DVD is seated correctly on the spindle by pressing down on the disc until it clicks in place. Then gently push in the tray.

NOTICE: Do not use the drive while the computer is in motion. Doing so could interrupt the flow of data between the disc and the hard-disk drive or diskette drive.

When the CD-ROM or DVD-ROM drive is in use, the drive access indicator blinks on the computer's front panel.

If you are using the Microsoft® Windows® 95 or Windows 98 operating system, disable the autoplay feature while you use the CD-ROM or DVD-ROM drive. (The autoplay feature can interfere with the computer's power management functions.) If Dell installed the operating system, the autoplay feature has been disabled. If you reinstall the operating system or if you installed it yourself, be sure to disable the autoplay feature if you want to use the CD-ROM or DVD-ROM drive.

For instructions on changing the **Auto Insert Notification** option, see the operating system user's guide.

Caring for CD, DVD, CD-RW Discs

When handling and using the discs, follow these precautions:

- Never use a damaged or warped disc.
 - Always hold the disc by its edges. Do not touch the surface of the disc.
 - Use a clean, dry cloth to remove dust, smudges, or fingerprints from the surface of the disc. When cleaning, wipe from the center of the disc to the edge.
 - Never use solvents, such as benzene, record cleaners, or antistatic sprays, to clean the disc.
 - Do not write on the surface of the disc.
 - Store disc in its containers, placing them in a cool, dry place. Extreme temperatures may damage discs.
 - Do not bend or drop a disc.
 - Do not place objects on top of a disc.
-

Types of Supported Discs

Your computer's CD-ROM, DVD-ROM, and CD-RW drives are able to play the following types of disc formats:

- CD-ROM red-book audio discs (CD-DA)
- CD-ROM yellow-book mode-1 and mode-2 data discs
- CD-ROM XA (mode-2 form 1 and form 2; without Adaptive Differential Pulse Code modulation)

[ADPCM])

- CD-I (mode-2 form 1 and form 2)
 - CD-I Ready
 - CD-Bridge
 - Photo CD, CD-recordable (CD-R) (single and multisession)
 - Video CD
 - CD-rewritable (CD-RW) (the 24x CD-ROM and DVD-ROM drives can read, but not write to, CD-RW discs; only the CD-RWs can write to this type of disc)
 - DVD-5 (the DVD-ROM drive supports the DVD-5 format)
-

[Back to Contents Page](#)

DualPoint Integrated Pointing Device: Dell™ Latitude™ CPx H-Series/J-Series User's Guide

[Cursor Pointing Devices](#)

[Customizing the DualPoint Integrated Pointing Device](#)

[Using the Touch Pad](#)

[Changing the Track Stick Cap](#)

[Using the Track Stick](#)

Cursor Pointing Devices

Your Dell portable computer is equipped with the unique Dell DualPoint integrated pointing device. The DualPoint integrated pointing device supports two types of cursor pointing devices (see [Figure 1](#) and [Figure 2](#)) that perform traditional mouse functions: the touch pad and the track stick. You can choose to use the touch pad only, the track stick only, or both at the same time.

Two sets of buttons located above and below the touch pad enable you to perform standard mouse functions with you thumb without removing your hands from the keyboard. You can also take advantage of "button-less" selection by simply clicking or double-clicking on either the touch pad or the track stick.

DualPoint integrated pointing device software allows you to set the default for the type of cursor pointing device you want to use, as well as sensitivity, motion, and drag and drop features of both the touch pad and track stick.



NOTES: When enabled, the DualPoint integrated pointing device (whether touch pad only, track stick only, or both) uses interrupt request (IRQ) 12. No other device can use IRQ12 while the DualPoint integrated pointing device is enabled.

When you attach an external PS/2-mouse to the computer, the DualPoint integrated pointing device is automatically disabled.

Using the Touch Pad

The Personal System/2 (PS/2) touch pad (see [Figure 1](#)) detects the position of your finger over a touch-sensitive area to position the cursor within the display screen. The touch pad provides the computer full mouse functionality. The touch pad's two buttons, located directly below the touch pad, correspond to the left and right buttons on a standard mouse.

Figure 1. PS/2 Touch Pad

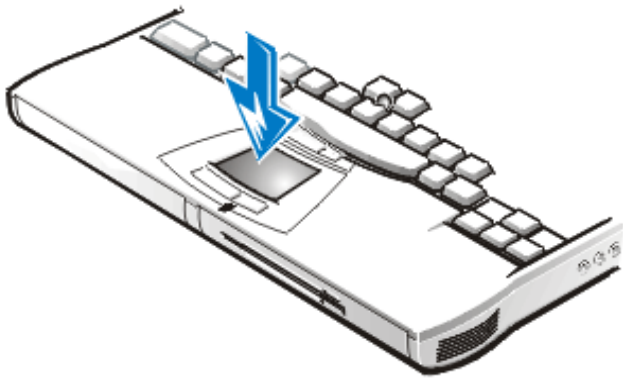

To best use the touch pad, use the following techniques:

- To move the cursor, lightly slide your finger over the smooth sensor area.
- To select an object, gently tap once on the surface of the touch pad or use your thumb to press the left touch pad button. The touch pad buttons perform standard mouse functions.
- To select and move (or drag) an object, position the cursor on the object and tap down-up-down on the touch pad. On the second down motion, leave your finger on the touch pad and move the selected object by sliding your finger across the surface.
- To double-click an object, position the cursor on the object and then tap the touch pad or the left touch pad button twice.

Using the Track Stick

The track stick (see [Figure 2](#)) detects the pressure and direction that you move your finger when touching the track stick cap located near the center of the keyboard. The two buttons located between the touch pad and the space bar on the keyboard correspond to the left and right buttons on a standard mouse.

Figure 2. Track Stick

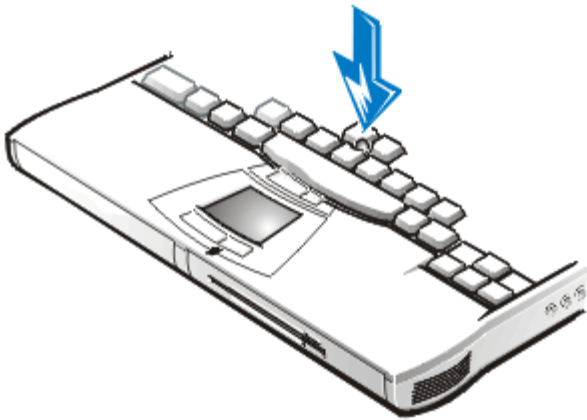

To best use the track stick, use the following techniques:

- To move the cursor, apply pressure to the track stick with your right or left index finger. Press up or down to move the cursor to the top or bottom of the display screen. Press left or right to move the cursor to the left or right of the display screen.

- To select an object, tap once on the track stick or use your thumb to press the left track stick button. The track stick buttons perform standard mouse functions.
 - To select and move (or drag) an object, position the cursor on the object. Then press and hold the left track stick button. Leave your thumb on the button and move the selected object by pressing the track stick in the desired direction.
 - To double-click an object, position the cursor on the object and then tap the left track stick button twice or tap the track stick itself twice. The track stick functions much like the touch pad in that it allows you to use buttons for mouse functions or the pointing device itself.
-

Customizing the DualPoint Integrated Pointing Device

The DualPoint integrated pointing device software allows you to set the default for the type of cursor pointing device you want to use, as well as sensitivity, motion, and drag and drop features of both the touch pad and track stick. To customize the DualPoint integrated pointing device, perform the following steps:

1. Click the **Start** button, point to **Settings**, and click **Control Panel**.
2. Double-click the **Mouse** icon to open the **Mouse Properties** window and click the **Touch** tab.
3. Select the settings that work best for you and click **Apply**.
4. Click **OK** to save the settings and close the window.

You can also click the touch pad icon on the taskbar and click **Touch Pad Properties** to open the **Mouse Properties** control panel.

Changing the Track Stick Cap

Your computer came with four additional track stick caps in assorted colors. You may need to change the track stick cap if it wears down from prolonged use.

To change the track stick cap, perform the following:

1. Pull the cap off the track stick (see Figure 3).

Figure 3. Removing the Track Stick Cap



2. Align a new cap over the square track stick post and gently press the cap down onto the post.
 3. Test the track stick to ensure that the cap is seated properly.
-

[Back to Contents Page](#)

Display: Dell™ Latitude™ CPx H-Series/J-Series User's Guide

- [Adjusting the Brightness](#)
- [Expanded Video Mode](#)
- [Video Drivers and Video Resolution](#)
- [Customizing Video Resolution](#)
- [Dual-Display Mode](#)
- [If You Have Display Problems](#)

Adjusting the Brightness

To accommodate local lighting conditions or video output from the software you are using, you can use the key combinations shown in [Table 1](#).



 *NOTE: When you run the computer on battery power, set your computer's brightness control to the lowest setting that affords comfortable viewing. You can conserve up to 10 percent of battery power by using the minimum brightness setting.*

Table 1. Brightness Key Combinations and Their Functions

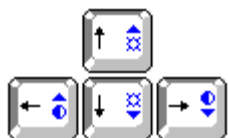

| Key Combinations | Function |
|-------------------|----------------------|
| <Fn> + down arrow | Decreases brightness |
| <Fn> + up arrow | Increases brightness |

 *NOTES: You cannot change contrast on an active-matrix (thin film transistor [TFT]) display.*

*To use key combinations on an external keyboard, enable the **External Hot Key** option in the System Setup program and use <Scroll Lock> instead of <Fn>.*

Expanded Video Mode

When working in text mode, you can select the font used to display text. Press <Fn><F7> to toggle between a regular serif font and a serif font with extra leading. Expanded video mode is useful if you are working in 800 x 600 resolution on a 14.1-inch XGA display.

 *NOTE: You may have trouble using the display fonts feature with MS-DOS® programs that use downloaded fonts.*

Video Drivers and Video Resolution

The Dell-installed video drivers work with the operating system to let you customize the video resolution and number of screen colors on your display.



NOTE: The Dell-installed video drivers are designed to offer the best performance on your computer. Dell recommends that you use only these drivers with your factory-installed operating system.

Table 2 lists the combinations of resolutions and colors that the computer supports.

Table 2. Display Resolution, Colors, and Refresh Rates

| Resolution | Color Depth | External CRT Display Available Refresh | Television as Secondary Display Available Refresh |
|---------------------|----------------|--|---|
| 640 x 480 (VGA) | 256 (8-bit) | 60, 75, 85 Hz | 60 Hz NTSC, 50 Hz PAL |
| 640 x 480 (VGA) | 65 k (16-bit) | 60, 75, 85 Hz | 60 Hz NTSC, 50 Hz PAL |
| 640 x 480 (VGA) | 16 M (24-bit) | 60, 75, 85 Hz | 60 Hz NTSC, 50 Hz PAL |
| 640 x 480 (VGA) | 4.2 B (32-bit) | 60, 75, 85 Hz | 60 Hz NTSC, 50 Hz PAL |
| | | | |
| 800 x 600 (SVGA) | 256 (8-bit) | 60, 75, 85 Hz | 60 Hz NTSC, 50 Hz PAL |
| 800 x 600 (SVGA) | 65 k (16-bit) | 60, 75, 85 Hz | 60 Hz NTSC, 50 Hz PAL |
| 800 x 600 (SVGA) | 16 M (24-bit) | 60, 75, 85 Hz | 60 Hz NTSC, 50 Hz PAL |
| 800 x 600 (SVGA) | 4.2 B (32-bit) | 60, 75, 85 Hz | 60 Hz NTSC, 50 Hz PAL |
| | | | |
| 1024 x 768 (XGA) | 256 (8-bit) | 60, 70, 75, 85 Hz | 60 Hz NTSC, 50 Hz PAL |
| 1024 x 768 (XGA) | 65 k (16-bit) | 60, 70, 75, 85 Hz | 60 Hz NTSC, 50 Hz PAL |
| 1024 x 768 (XGA) | 16 M (24-bit) | 60, 70, 75, 85 Hz | 60 Hz NTSC, 50 Hz PAL |
| 1024 x 768 (XGA) | 4.2 B (32-bit) | 60, 70, 75, 85 Hz | 60 Hz NTSC, 50 Hz PAL |
| | | | |
| 1280 x 1024 (SXGA)* | 256 (8-bit) | 60, 70, 75, 85 Hz | 60 Hz NTSC, 50 Hz PAL |
| 1280 x 1024 (SXGA)* | 65 k (16-bit) | 60, 70, 75, 85 Hz | 60 Hz NTSC, 50 Hz PAL |
| 1280 x 1024 (SXGA)* | 16 M (24-bit) | 60, 70, 75, 85 Hz | 60 Hz NTSC, 50 Hz PAL |
| 1280 x 1024 (SXGA)* | 4.2 B (32-bit) | 60, 70, 75, 85 Hz | 60 Hz NTSC, 50 Hz PAL |
| | | | |
| | | | |

| | | | |
|--------------------|----------------|--------------|-----------------------|
| 1600 x 1200 (UGA)* | 256 (8-bit) | 60 Hz, 85 Hz | 60 Hz NTSC, 50 Hz PAL |
| 1600 x 1200 (UGA)* | 65 k (16-bit) | 60 Hz, 85 Hz | 60 Hz NTSC, 50 Hz PAL |
| 1600 x 1200 (UGA)* | 16 M (24-bit) | 60 Hz, 85 Hz | 60 Hz NTSC, 50 Hz PAL |
| 1600 x 1200 (UGA)* | 4.2 B (32-bit) | 60 Hz, 85 Hz | 60 Hz NTSC, 50 Hz PAL |

**NOTE: Pan mode may be turned on for the 1280 x 1024 (SXGA), 1400 x 1050 (SXGA Plus), and 1600 x 1200 (UGA) computer displays. In pan mode the screen resolution is too high to be completely displayed on the computer display. For example, the taskbar that usually appears at the bottom of the desktop may no longer be visible. To view the rest of the screen, use the touch pad or track stick to pan up and down and left and right.*

NOTICE: Before adjusting the refresh rate on an external monitor, refer to the monitor's user's guide. You can damage the monitor by using an unsupported refresh rate.

To display more colors, select a lower resolution. If you select a resolution and color combination that the system does not support, the system automatically selects the next supported combination.



NOTE: Color depth is based on 256 colors for 8 bit, 65,536 colors for 16 bit, 16,842,752 colors for 24 bit, and 4,294,967,296 colors for 32 bit displays.

Table 3 lists the maximum color depth possible for various combinations of resolutions without DVD and 3D.

Table 3. Display Resolution and Color Depth Without DVD and 3D Running

| | Maximum Color Depth Possible (in bits) | | | |
|----------------------|--|-----------|------------|-------------|
| Primary/Secondary | 640 x 480 | 800 x 600 | 1024 x 768 | 1280 x 1024 |
| 640 x 480 (8 bit) | 32 | 32 | 32 | 32 |
| 800 x 600 (8 bit) | 32 | 32 | 32 | 32 |
| 1024 x 768 (8 bit) | 32 | 32 | 32 | 32 |
| 1280 x 1024 (8 bit) | 32 | 32 | 32 | 32 |
| 1600 x 1200 (8 bit) | 32 | 32 | 32 | 32 |
| | | | | |
| 640 x 480 (16 bit) | 32 | 32 | 32 | 32 |
| 800 x 600 (16 bit) | 32 | 32 | 32 | 32 |
| 1024 x 768 (16 bit) | 32 | 32 | 32 | 32 |
| 1280 x 1024 (16 bit) | 32 | 32 | 32 | 32 |
| 1600 x 1200 (16 bit) | 32 | 32 | 24 | 24 |
| | | | | |
| 640 x 480 (24 bit) | 32 | 32 | 32 | 32 |

| | | | | |
|----------------------|----|----|----|----|
| 800 x 600 (24 bit) | 32 | 32 | 32 | 32 |
| 1024 x 768 (24 bit) | 32 | 32 | 32 | 32 |
| 1280 x 1024 (24 bit) | 32 | 32 | 32 | 24 |
| 1600 x 1200 (24 bit) | 24 | 24 | 16 | 8 |
| | | | | |
| 640 x 480 (32 bit) | 32 | 32 | 32 | 32 |
| 800 x 600 (32 bit) | 32 | 32 | 32 | 32 |
| 1024 x 768 (32 bit) | 32 | 32 | 32 | 24 |
| 1280 x 1024 (32 bit) | 32 | 32 | 24 | 16 |
| 1600 x 1200 (32 bit) | 8 | 8 | -- | -- |

Customizing Video Resolution

1. Click the **Start** button, point to **Settings**, and then click **Control Panel**.

The **Control Panel** window appears.

2. Double-click the **Display** icon.

The **Display Properties** window appears.

3. Click the **Settings** tab, and then set the resolution by dragging the slider in the **Screen Area** box. In the **Colors** box, choose the number of colors from the menu provided. For more information, see your operating system documentation.

If you choose a resolution or color palette that is higher than the display supports, the settings adjust automatically to the closest possible setting.

Dual-Display Mode

With the Microsoft® Windows® 98 operating system, you can use an external monitor as an extension of your display. To set up your computer for dual-display mode, perform the following steps:

1. Connect the [external monitor](#), TV, or projector.
2. Click the **Start** button, point to **Settings**, and then click **Control Panel**.
3. In the **Control Panel** window, double-click the **Display** icon.
4. In the **Display Properties** window, click the **Settings** tab.
5. Change the **Colors** option to **256 Color** or **True Color (24 bit)**.

6. Change the **Screen Area** to the appropriate size for your display.
7. Click the **Advanced...** button.
8. When the **RAGE MOBILITY -M1 Properties** window appears, select the **Displays** tab.
9. Click the **Monitor** button.

The dual display option is activated.

10. Click **Yes** when prompted to restart your system.
11. When the system has restarted, reopen the **Display** icon in the **Control Panel**.
12. Click the **Settings** tab.

Two displays now appear in this window.

13. Click the display that is grayed out. When asked if you want to enable this display, click **Yes**, and then click **Apply**.



NOTE: True Simul-mode (the ability to simultaneously display video of the same content and resolution on both the computer display screen and the external display) is not supported if the system is booted to MS-DOS®, using a full-screen MS-DOS session under a Microsoft Windows operating system, or the ATI Mobility M1 video driver is not loaded. This limitation may also be noted in operating systems other than Microsoft Windows.

If You Have Display Problems

If your computer is receiving power, but nothing appears on your display (such as light, text, or graphics) or the display image does not appear as you would expect, try the following measures to resolve the problem:

1. If the display is blank, you may be in suspend or standby mode. Press the power button to resume from suspend mode or standby mode. If the display is blank and the power light-emitting diode (LED) is on, the display may have timed out. In this case, press any key on the keyboard or move the mouse to resume normal operation.
2. If the low-battery light is blinking, connect the AC adapter to the computer or replace the battery.
3. Adjust the brightness.
4. If your computer is attached to an external monitor, press <Fn><F8> to switch the video image to the display.

Securing Your Computer: Dell™ Latitude™ CPx H-Series/J-Series User's Guide

- [About Passwords](#)
- [Using a Primary Password](#)
- [Using an Administrator Password](#)
- [Using a Hard-Disk Drive Password](#)
- [Physically Securing the Computer and the Hard-Disk Drive](#)
- [Asset Tag Utility](#)

About Passwords

A primary password prevents unauthorized access to the computer at start-up. An administrator password can be used in place of the primary password. A hard-disk drive password helps prevent the unauthorized access of data on the hard-disk drive, even when the device is placed into another computer.

 *NOTES: All three passwords are disabled when you receive your computer. You need to assign those passwords if you require password security for your computer. Some companies may assign any or all of these passwords before distributing the computer.*

If you are using the Microsoft® Windows NT® operating system, use the System Setup program to assign all passwords.

NOTICE: The password features provide a high level of security for the data in your computer or hard-disk drive. However, they are not foolproof. If your data requires more security, you should obtain and use additional forms of protection, such as data encryption programs or PC Cards with encryption features.

If you forget any of your passwords, [call Dell](#). For your protection, Dell's technical support staff will ask you for proof of your identity to make sure that an unauthorized person is not trying to use the computer.

Using a Primary Password

The primary password allows you to protect the computer from unauthorized access.

After assigning a primary password, you must enter it each time you turn on your computer. The following message appears each time you turn on the computer:

Please type in the primary or administrator password and press <Enter>.

To continue, type your password and press <Enter>.

 *NOTE: If no password is entered within 2 minutes, the computer returns to its previous state.*

If you have assigned an administrator password, you can use it instead of the primary password. The computer does not specifically prompt you for the administrator password.

NOTICE: If you disable the administrator password, the primary password is also disabled.

Using an Administrator Password

The administrator password is designed to give system administrators or service technicians in large companies access to computers for repair or reconfiguration. The administrators or technicians can assign identical administrator passwords to groups of computers as they are unpacked and configured, leaving the primary password free to be assigned by the user.

When you set an administrator password, the [Configure Setup](#) option becomes available in the System Setup program. The **Configure Setup** option allows you to restrict access to the System Setup program in the same way a system password restricts access to the system.

The administrator password can be used in place of the primary password. Whenever you are prompted to enter the primary password, you can enter the administrator password instead.



NOTE: The administrator password provides access to the system, but it does not provide access to the hard-disk drive when it is protected by a password.

If you forget the primary password and do not have an administrator password assigned, or if you have both a primary and an administrator password assigned but forget them both, [call Dell](#).

NOTICE: If you disable the administrator password, the primary password is also disabled.

Using a Hard-Disk Drive Password

The hard-disk drive password helps protect the data on your hard-disk drive from unauthorized access. You can also assign a password for the modular hard-disk drive (if one is being used) that can be the same as or different from the password for the primary hard-disk drive.



NOTE: Only hard-disk drives purchased from Dell for use with the Latitude C-Family of portable computers support the hard-disk drive password option.

After assigning a hard-disk drive password, you must enter it each time you turn on the computer and each time you resume normal operation from suspend mode or standby mode.

If the hard-disk drive password is enabled, the following message appears each time you turn on the computer:

Please type in the hard-disk drive password and press <Enter>.

To continue, enter the hard-disk drive password. Press <Esc> to return the computer to its previous state—suspend or standby mode.



NOTE: If no password is entered within 2 minutes, the computer returns to its previous state.

If you enter the wrong password, the following message appears:

Invalid password
[Press Enter to retry]

If the correct password is not entered in three attempts, the computer tries to boot from another bootable device if the [Boot First device](#) option in the System Setup program is set to allow it. If the **Boot First device** option is not set to allow booting from another device, the computer returns to the state it was in when you turned it on—suspend or standby mode.



NOTES: If the hard-disk drive password, the modular hard-disk drive password, and the primary password are the same, you are prompted only for the primary password. If the hard-disk drive password is different from the primary password, you are prompted for both. Two different passwords provide greater security.

The administrator password provides access to the system, but it does not provide access to the hard-disk drive when it is protected by a password.

Physically Securing the Computer and the Hard-Disk Drive

To prevent unauthorized removal of the computer, you can use a security cable to attach the computer to an immovable object. Your computer has two security cable slots: One security cable slot is located between the speaker and the hard-disk drive. (See [Figure 1](#) in "Introduction.") The other security cable slot is located between the S-Video connector and the fan's air intake. (See [Figure 2](#) in "Introduction.")

Description of Security Cable Slots

The security cable slots allow you to attach a commercially available antitheft device to the computer. Antitheft devices for portable computers usually include a segment of metal-stranded cable with an attached locking device and associated key.

When your computer is installed in a Dell Latitude C/Dock Family Expansion Station, use the security cable slot located between the S-Video connector and the fan's air intake to secure your computer.

You can use either security cable slot to secure your computer when it is not docked to a Dell Latitude C/Dock Family Expansion Station. However, to lock your computer and prevent unauthorized removal of the hard-disk drive, insert the locking device into the security cable slot located between the hard-disk drive and the speaker, and lock the device with its associated key.

Basic Instructions for Using Security Cable Slots

To prevent unauthorized removal of your computer, loop the cable around an immovable object, insert the locking device into either of the security cable slots, and lock the device. See [Figure 1](#) for an example of how to secure your computer. Complete instructions for installing this kind of antitheft device are usually included with the device.

Figure 1. Securing the Computer

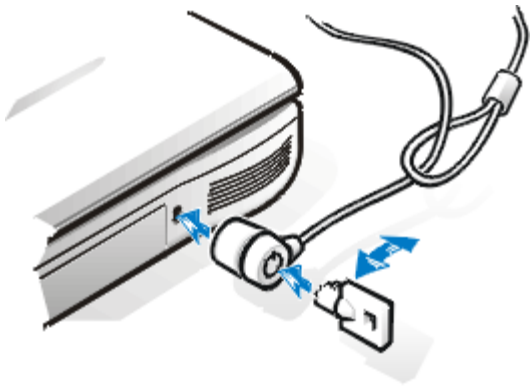

NOTE: Antitheft devices differ in design. Before purchasing such a device, make sure that it will work with the security cable slot in your computer.

Asset Tag Utility

Dell has installed the Asset Tag utility on your computer. The Asset Tag utility allows you to enter an asset tag number that you or your company assigns to the computer. The default System Setup screens do not show the asset tag number unless you enter one by using this utility.

You can also use the Asset Tag utility to enter an owner tag that appears in the system log-on screen and with the primary password prompt.

Viewing Existing Asset Tag and Service Numbers

To view existing asset tag and service tag numbers, perform the following steps:

1. Click the **Start** button, point to **Programs**, and click **MS-DOS Prompt**.
2. Type `cd c:\Dell\Util` and press <Enter>.
3. Type `asset` and press <Enter>.

Assigning an Asset Tag Number

An asset tag number can have up to ten characters; any combination of characters excluding spaces is valid. To assign or change an asset tag number, perform the following steps:

1. Click the **Start** button, point to **Programs**, and click **MS-DOS Prompt**.
2. Type `cd c:\Dell\Util` and press <Enter>.
3. Type `asset` and a space followed by the new number, and press <Enter>.

For example, type the following command line and press <Enter>:

```
asset 1234$ABCD&
```

4. When the system prompts you to verify the asset tag number, type `y` and press <Enter>.

The system displays the new or modified asset tag number and the service tag number.

Deleting an Asset Tag Number

To delete the asset tag number without assigning a new one, perform the following steps:

1. Click the **Start** button, point to **Programs**, and click **MS-DOS Prompt**.
2. Type `cd c:\Dell\Util` and press <Enter>.
3. Type `asset /d` and press <Enter>.

Assigning an Owner Tag

An owner tag can have up to 48 characters; any combination of letters, numbers, and spaces is valid. To assign an owner tag, perform the following steps:

1. Click the **Start** button, point to **Programs**, and click **MS-DOS Prompt**.
2. Type `cd c:\Dell\Util` and press <Enter>.
3. Type `asset /o` and a space followed by the new owner tag, and press <Enter>.

For example, type the following command line and press <Enter>:

```
asset /o ABC Company
```

4. When the system prompts you to verify the owner tag, type `y` and press <Enter>.

The system displays the new owner tag.

Deleting an Owner Tag

To delete the owner tag without assigning a new one, perform the following steps:

1. Click the **Start** button, point to **Programs**, and click **MS-DOS Prompt**.
2. Type `cd c:\Dell\Util` and press <Enter>.
3. Type `asset /o /d` and press <Enter>.



NOTE: For security, you cannot set, change, or delete the owner tag if the primary or administrator passwords are set.

[Table 1](#) lists the command-line options you can use with the Asset Tag utility. To use one of these options, open an MS-DOS® prompt, type `asset` and a space followed by the option, and then press <Enter>.

Table 1. Asset Tag Utility Command-Line Options

| Asset Tag |
|-----------|
| |

| Option | Description |
|----------|--|
| /d | Deletes the asset tag number |
| /o <tag> | Specifies a new owner tag |
| /o /d | Deletes the owner tag |
| /? | Displays the Asset Tag utility help screen |

[Back to Contents Page](#)

Diskette Drive: Dell™ Latitude™ CPx H-Series/J-Series User's Guide

Your computer was shipped with a 3.5-inch diskette drive (see [Figure 1](#)) in the modular bay. To use another device in the modular bay, first remove the diskette drive. For detailed instructions on installing devices in the modular bay, see "[Using the Modular Bay](#)."



NOTE: If the computer is docked to the C/Port Family Advanced Port Replicator (APR) or the C/Dock Family Expansion Station, turn off the computer and undock it before installing or removing a diskette drive.

The diskette drive lets you install programs and transfer data using 3.5-inch diskettes.

Figure 1. Diskette Drive Installed in Computer



To use the diskette drive, insert a 3.5-inch diskette into the drive (label side up and metal end first). Push the diskette into the drive until the eject button extends outside the drive casing.

NOTICE: Do not travel with a diskette in the diskette drive. Doing so could break the eject button and damage the drive.

To remove a diskette from the drive, press the eject button to release the diskette, and then pull the diskette out of the drive.

When data is being accessed from the diskette drive in the modular bay, the drive access indicator blinks.



NOTE: You can use the diskette drive externally by connecting it to the parallel connector on the back of the computer. If you are running either the Microsoft® Windows® 95, Windows 98, or Windows 2000 operating system on your computer and the [Diskette Reconfig](#) option is enabled in the System Setup program, you do not have to reboot the computer when you connect the diskette drive to the parallel connector. If you are running the Microsoft Windows NT® operating system on your computer, you do need to reboot the computer after you connect the diskette drive.

Connecting External Devices: Dell™ Latitude™ CPx H-Series/J-Series User's Guide

[Connectors](#)

[Audio](#)

[S-Video TV-Out](#)

[Keyboard](#)

[Keypad](#)

[Mouse](#)

[Diskette Drive](#)

[Connecting an External Monitor](#)

[Using an External Monitor](#)

Connectors

Use Figure 1 to locate the connectors on the back of the computer.

NOTICE: When disconnecting external devices from the back of the computer, wait 5 seconds after turning off the computer before you disconnect a device to avoid possible damage to the system board.

Figure 1. I/O Connectors

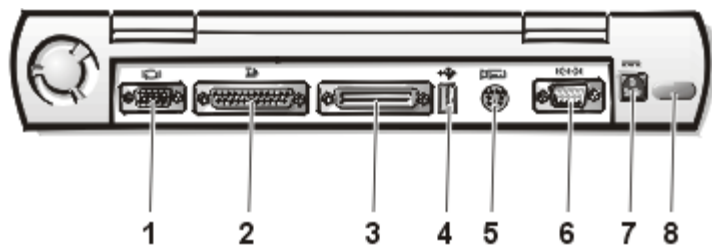

1 Video connector

2 Parallel connector

3 Docking connector

4 USB connector

5 PS/2 connector

6 Serial connector

7 AC power connector

8 Infrared port

Use Figure 2 to locate the connectors on the side of the computer.

Figure 2. I/O Connectors on Right Side of Computer

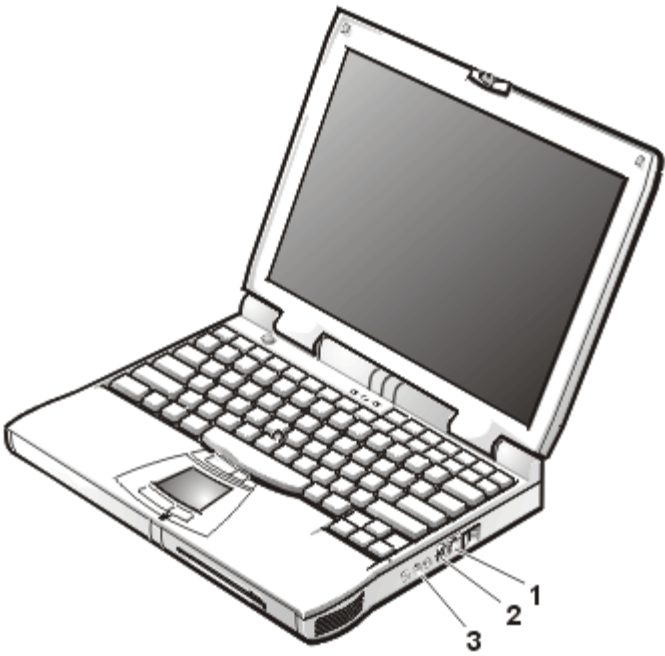

- 1 Internal modem connector (available only on Cpt S-Series)
- 2 S-Video connector
- 3 Audio jacks (3)

Audio

You can connect audio devices such as speakers, microphones, headphones, and record/playback devices to your computer. The following information tells you how to connect the cables. [Figure 3](#) shows the locations of the audio jacks and the S-Video connector.

- Connect the audio cable from a microphone to the microphone jack, also called the MIC IN jack.
- Connect the audio cable from the speakers to the headphones/speakers jack, also called the line-out/speaker-out jack.
- Connect the line-out cable from a record/playback device to the line-in/audio-in jack. Cassette players, CD players, radios, stereo systems, and tape players are all record/playback devices.
- Connect the S-Video input/output (I/O) cable from a record/playback device to the S-Video connector. VCRs and video cameras are record/playback devices.

Figure 3. Connecting Audio and S-Video Devices

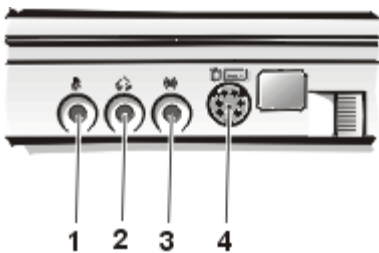

- 1 Microphone (MIC IN)
- 2 Speakers and headphones (line-out/speaker-out)
- 3 Record/Playback (line-in/audio-in)
- 4 S-Video connector



NOTE: The C/Port Family Advanced Port Replicator (APR) also has a headphones/speaker jack. The C/Dock Family Expansion Station has all three jacks.

If your computer is running the Microsoft® Windows® 95 operating system, you can control the sound on your computer through the **Dell Control Center Speaker** window, the System Setup program, and key combinations.

S-Video TV-Out

You can connect a television with an S-Video connector to your computer. [Figure 3](#) shows the location of the S-Video connector.

To connect the cables, follow these guidelines:

- If your television uses an S-Video cable for video input, connect one end of that cable directly to your computer's S-Video TV-out connector and the other end into your television's S-Video connector. Connecting the S-Video cable that came with your television to the television's S-Video connector and to the S-Video TV-out connector on your computer allows your computer to output video information to your television.
- If your television uses a composite video cable for video input, you need both the Composite TV-Out Adapter cable that came with your computer and the composite video cable that came with your television. Connecting these cables together, then connecting them to your television composite video-in connector and your computer's S-Video TV-out connector, allows your computer to output video information to your television.

To connect a television which has a composite video-in connector to your computer's S-Video TV-out connector, perform the following steps:

1. Connect the Composite TV-Out Adapter cable that came with your computer to your computer's S-Video TV-out connector.
 2. Connect the other end of the Composite TV-Out Adapter cable to your television's composite video cable.
 3. Connect the composite video cable to your television's composite video connector.
-

Keyboard

You can attach a Personal System/2 (PS/2)-compatible external 101- or 102-key keyboard to the computer's mini-Deutsche Industrie Norm (DIN) connector, as shown in Figure 4.

Figure 4. Attaching an External Keyboard

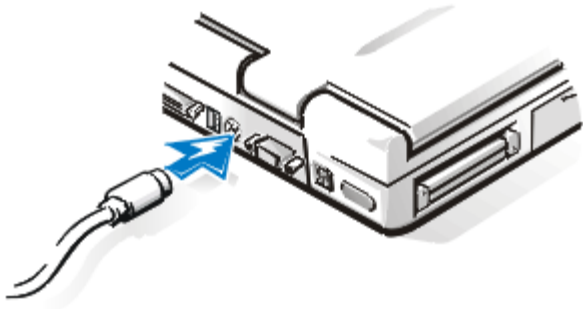

 **NOTE:** *If the computer is in suspend mode or suspend-to-disk mode when you attach an external keyboard, the device is recognized immediately by the computer when it resumes normal operation.*

You can use the computer's keyboard and an external keyboard at the same time. When you attach a keyboard to the computer, the embedded numeric keypad is automatically disabled.

On an external keyboard, the <Scroll Lock> key acts the same way as the <Fn> key on the computer's keyboard (if the **External Hot Key** option is enabled in the System Setup program).

You can also connect an external keyboard to the C/Port Family APR or the C/Dock Family Expansion Station.

Keypad

You can attach a PS/2-compatible external numeric keypad to the computer's mini-DIN keypad connector.

 **NOTE:** *If the computer is in suspend mode or suspend-to-disk mode when you attach an external keypad, the device is recognized immediately by the computer when it resumes normal operation.*

When you attach a numeric keypad to the computer, the embedded numeric keypad is automatically disabled. The indicators on the integrated keyboard track the operation of an external numeric keypad.

You can also connect an external keypad to the C/Port Family APR or C/Dock Family Expansion Station.

Mouse

You can attach a PS/2-compatible mouse to the computer's mini-DIN mouse connector, as shown in Figure 5.

Figure 5. Connecting an External Mouse

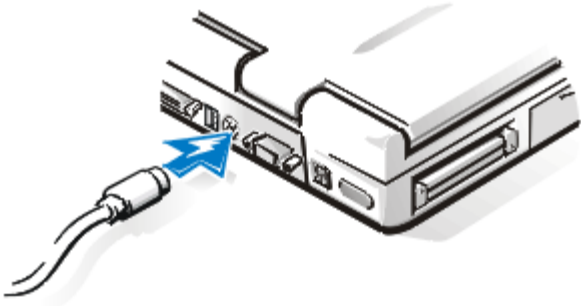

NOTE: If the computer is in suspend mode or suspend-to-disk mode when you attach an external mouse, the device is recognized immediately by the computer when it resumes normal operation. However, programs that were already running may need to be restarted in order to recognize the mouse.

When you attach a PS/2 mouse to the computer, the DualPoint integrated pointing device is automatically disabled. If you disconnect the mouse, you must shut down the computer or enter suspend or standby mode and then resume from it before the DualPoint integrated pointing device is operational. If you do not do this, the DualPoint integrated pointing device resumes operation in standard PS/2 mode, which means that many of the configuration features are disabled.

If you are using a PS/2-compatible mouse that is not made by Microsoft and the mouse does not work properly, reboot the computer. If the mouse still does not work, install the drivers from the diskette that came with the mouse and reboot the computer.

You can also connect an external mouse to the C/Port Family APR or the C/Dock Family Expansion Station.

Diskette Drive

The diskette drive can be used as an external device if you have a CD-ROM, DVD-ROM, second hard-disk, or LS-120 drive; battery; or travel module in the modular bay. The external diskette drive letter is A. If there is a diskette drive in the modular bay, the external diskette drive letter is B.

Use the parallel diskette drive cable that came with the computer to connect the drive to the parallel connector on the I/O panel, as shown in Figure 6.

Figure 6. Using the Diskette Drive As an External Device

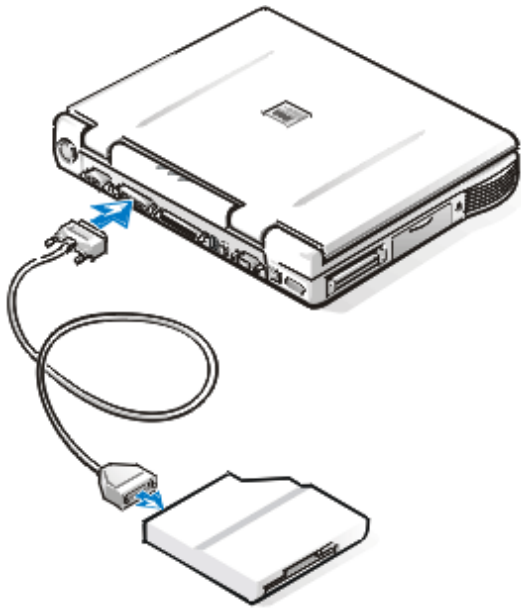

NOTICE: When the diskette drive is not being used externally, remove the parallel diskette drive cable from the parallel connector.

NOTICE: Use the parallel diskette drive cable only with the diskette drive. Do not try to connect any other device to the computer with this cable.

If the [Diskette Reconfig](#) option is set to **Any Time** in the System Setup program, you do not have to turn the computer off when you connect the diskette drive to the parallel connector.

The drive access indicator does not blink when data is being accessed from the diskette drive connected to the parallel connector.

NOTICE: Protect the diskette drive when it is not in the modular bay. Do not squeeze the drive or place objects on top of it; doing so could damage the drive motor.

Connecting an External Monitor

The computer's video connector is used to connect an external monitor to the computer. To attach an external monitor, perform the following steps.

NOTICE: Do not place the monitor directly on top of your portable computer, even if it is closed. Doing so can crack the computer case, the display, or both.

1. Make sure that the external monitor is turned off. Set the monitor on a monitor stand, desk top, or other level surface near your computer.
2. Connect the external monitor's video cable to the computer.

Plug the video cable connector into the matching video connector on the back of the computer, as shown in Figure 7. If the video cable is not permanently attached to the monitor, connect it to the monitor also.

Figure 7. Connecting an External Monitor

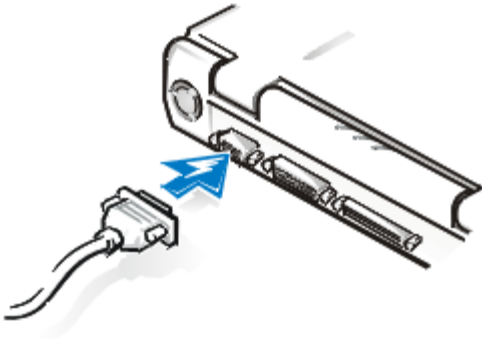

Be sure to tighten all the screws on the video cable connector(s) to eliminate radio frequency interference (RFI).

3. Connect your external monitor to a grounded electrical outlet.

Plug the three-prong connector on one end of the monitor's power cable into a grounded power strip or some other grounded power source. If the cable is not permanently attached to the monitor, connect it to the monitor also.

You can also connect an external monitor to the C/Port Family APR or the C/Dock Family Expansion Station.



NOTE: If you are using the Microsoft Windows 98 operating system, you can use an external monitor as an extension of your display. For more information, see the Windows 98 documentation or "[Dual-Display Mode](#)."

Using an External Monitor

When an external monitor is connected to the computer, the video image automatically appears on the external monitor's screen when you boot your computer.

To toggle the video image between the display, an external monitor, or both simultaneously, press <Fn><F8> on the keyboard. Press <Scroll Lock><F8> on an external keyboard if the **External Hot Key** option is enabled in the System Setup program.

If the external monitor is turned off when you boot your computer, the computer still sends the video image to the external monitor. In this case, you will not see an image on either the computer's display or the external monitor. To see an image, turn on the external monitor or switch the video image to the computer's display by pressing <Fn><F8> on the keyboard or <Scroll Lock><F8> on an external keyboard if the **External Hot Key** option is enabled in the System Setup program.

[Back to Contents Page](#)

Keyboard: Dell™ Latitude™ CPx H-Series/J-Series User's Guide

- [Embedded Numeric Keypad](#)
- [Speaker Key Combinations](#)
- [Display Key Combinations](#)
- [System Function Key Combinations](#)
- [Power Conservation Key Combinations](#)
- [Optical Media Drive Key Combinations](#)
- [Processing Speed Key Combinations](#)

Embedded Numeric Keypad

As you work, you may want to use the embedded numeric keypad (see [Figure 1](#)) to enter numbers in spreadsheet or financial programs. The embedded numeric keypad shares some of the keys on your computer's keyboard. The number and symbol characters are marked to the right on these keys. To activate the embedded numeric keypad, press <Num Lk>. The Num Lock indicator lights up.

Figure 1. Embedded Numeric Keypad

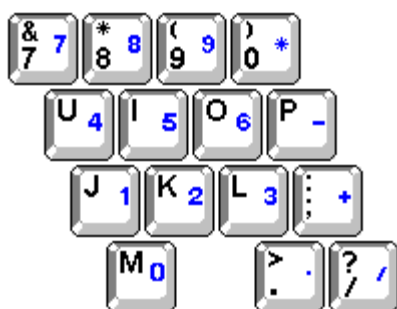

Some key combinations can be used whether the keypad is off or on.

 **NOTE:** On an external keyboard, use <Scroll Lock> with the appropriate keys if the **External Hot Key** option is enabled in the System Setup program.

Use the numeric keypad combinations in Table 1 to enable and disable several numeric keypad functions.

Table 1. Embedded Numeric Keypad Key Combinations

| When Keypad Is On | Function |
|-------------------|--|
| <Num Lk> | Toggles the embedded numeric keypad off |
| <Fn><key> | Temporarily disables the embedded numeric keypad; enables the lowercase characters/functions of the keyboard |
| <Fn><Shift><key> | Temporarily disables the embedded numeric keypad; enables the uppercase characters/functions of the keyboard |

| | |
|---------------------------|---|
| <Shift><cursor key> | Temporarily enables a cursor-control key in the embedded numeric keypad |
| When Keypad Is Off | Function |
| <Num Lk> | Toggles the embedded numeric keypad on |
| <Fn><cursor key> | Temporarily enables a cursor-control key in the embedded numeric keypad |
| <Fn><Shift><number key> | Temporarily enables a number or symbol key in the embedded numeric keypad |

Display Key Combinations



NOTE: On an external keyboard, use <Scroll Lock> with the appropriate keys if the **External Hot Key** option is enabled in the System Setup program.

Use the key combinations in Table 2 to adjust the computer's display.

Table 2. Display Key Combinations

| Key Combinations | Function |
|--|--|
| <Fn> + down arrow | Incrementally decreases brightness. |
| <Fn> + up arrow | Incrementally increases brightness. |
| <Fn> + right arrow | Decreases contrast, which has no effect on an active-matrix display. (Not supported on DSTN screens. ¹) |
| <Fn> + left arrow | Increases contrast, which has no effect on an active-matrix display. (Not supported on DSTN screens. ¹) |
| <Fn><F5> (not supported on Dell Latitude CPx H-Series/J-Series) | Toggles the computer's display between regular video mode and reverse video mode (white on black). This key combination works only if the computer is in text mode; it has no effect if the computer is running a graphical operating system or application program. (Not supported on the Dell Latitude CPx H-Series/J-Series portable computer with ATI Mobility M1 video controller.) |
| <Fn><F7> | Toggles the computer's display between expanded mode and regular video mode. |
| <Fn><F8> | Switches the video image to the next display in the following sequence: the display, an external monitor, or both displays simultaneously. This key combination may not be supported under certain conditions. ² |

| | |
|---------|---|
| <Fn><d> | Turns off the display. This key combination may not be supported under certain conditions. ³ |
|---------|---|

¹ Contrast cannot be changed on an active-matrix (thin film transistor [TFT]) display.

To use key combinations on an external keyboard, enable the **External Hot Key** option in the System Setup program and use <Scroll Lock> instead of <Fn>.

² True Simul-mode (the ability to simultaneously display video of the same content and resolution on both the computer display screen and the external display) is not supported if the system is booted to MS-DOS®, using a full-screen MS-DOS session under a Microsoft® Windows® operating system, or the ATI Mobility M1 video driver is not loaded. This limitation may also be noted in operating systems other than Microsoft Windows.

³ Certain key combinations may not function with the Advanced Configuration and Power Interface (ACPI) or may require configuration with the **Power Management Properties** window in the **Control Panel**. See [Power Management Settings](#).

Power Conservation Key Combinations

 **NOTE:** On an external keyboard, use <Scroll Lock> with the appropriate keys if the **External Hot Key** option is enabled in the System Setup program.

Use the key combinations in Table 3 to activate or turn off the computer's power conservation features.

Table 3. Power Conservation Key Combinations

| Key Combinations | Function |
|---|---|
| <Fn><d> | Turns off the display* |
| <Fn><h> | Turns off the hard-disk drive* |
| <Fn><Esc> | Activates suspend, sleep, or standby mode |
| <Fn><a> or <Fn><q> on French keyboards | Activates suspend-to-disk mode* |

* This key combination does not function with ACPI if the settings have not been configured with the **Power Management Properties** window in the **Control Panel**. See [Power Management Settings](#).

Processing Speed Key Combinations

 **NOTE:** On an external keyboard, use <Scroll Lock> with the appropriate keys if the **External Hot Key**

option is enabled in the System Setup program.

Use the key combinations in Table 4 to change the computer's processing speed.

Table 4. Processing Speed Key Combinations

| | |
|-----------|--|
| <Fn><↓> | Switches between the microprocessor's maximum speed and a slower compatibility speed |
| <Ctrl><↓> | In full MS-DOS mode or in a full-screen MS-DOS box, switches between the microprocessor's maximum speed and a slower compatibility speed |

Speaker Key Combinations



NOTE: On an external keyboard, use <Scroll Lock> with the appropriate keys if the **External Hot Key** option is enabled in the System Setup program.

Use the key combinations in Table 5 to adjust the computer's speaker volume and to enable and disable the speakers.

Table 5. Speaker Key Combinations

| Key Combinations | Function |
|------------------|---|
| <Fn><Page Up> | Volume Up: Increases the volume of the integrated speakers and the external speakers, if attached |
| <Fn><Page Dn> | Volume Down: Decreases the volume of the integrated speakers and the external speakers, if attached |
| <Fn><End> | Mute Toggle: Enables and disables the integrated speakers and the external speakers, if attached |

System Function Key Combinations



NOTE: On an external keyboard, use <Scroll Lock> with the appropriate keys if the **External Hot Key** option is enabled in the System Setup program.

Use the key combinations in Table 6 to access MS-DOS, open the System Setup program, and open the **Battery Status** screen of the System Setup program.

Table 6. System Function Key Combinations

| Key Combinations | Function |
|------------------|---|
| <Ctrl><Alt> | Restarts (reboots) the computer in MS-DOS mode. |

| | |
|-----------|---|
| | For Microsoft Windows 95, Windows 98, Windows 2000, and Windows NT® operating systems, click the Start button and click Shut Down . |
| <Fn><F1>* | Opens the System Setup program. |
| <Fn><F3>* | Opens the Battery Status screen of the System Setup program. |

* *This key combination does not function with ACPI.*

Optical Media Drive Key Combinations



*NOTE: On an external keyboard, use <Scroll Lock> with the appropriate keys if the **External Hot Key** option is enabled in the System Setup program.*

To eject drive, press <Fn><F10>.

[Back to Contents Page](#)

I/O Connectors: Dell™ Latitude™ CPx H-Series/J-Series User's Guide

[About the I/O Connectors](#)

[Video Connector](#)

[Parallel Connector](#)

[Docking Connector](#)

[USB Connector](#)

[PS/2 Connector](#)

[Serial Connector](#)

[AC Power Connector](#)

[Infrared Port](#)

About the I/O Connectors

You can connect external devices to the input/output (I/O) connectors. The computer's basic input/output system (BIOS) detects the presence of external devices when you boot (start) or reboot your computer. Figure 1 shows the connectors on the back of your computer.

 **NOTE:** For more information, see "[Connecting External Devices](#)."

NOTICE: When disconnecting external devices from the back of the computer, wait 5 seconds after turning off the computer before you disconnect a device to avoid possible damage to the system board.

Figure 1. I/O Connectors

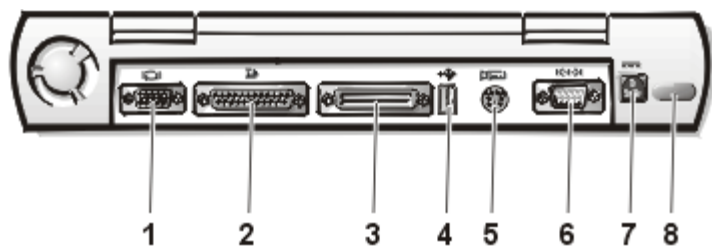

1 Video connector

2 Parallel connector

3 Docking connector

4 USB connector

5 PS/2 connector

6 Serial connector

7 AC power connector

8 Infrared port



NOTE: Some external devices require you to load software called device drivers into system memory before the devices will work. These device drivers help your computer recognize the external device and direct its operation. Instructions for installing this software are usually included in the upgrade kits.

Video Connector

Use the 15-hole video connector to attach an external monitor to the computer. See "[Connecting an External Monitor](#)" for more information about connecting an external monitor.

Parallel Connector

Use the 25-hole parallel connector to attach a parallel device to the computer. The parallel connector is used primarily for printers. You can also connect the diskette drive to the parallel connector.

The parallel port sends and receives data in parallel format, where eight data bits (one byte) are sent simultaneously over eight separate lines. The port can be configured as a unidirectional (output-only) port for devices such as a printer or as a bidirectional port for devices such as a network adapter.

The computer's integrated parallel port is designated as LPT1. The Microsoft® Windows® operating systems automatically recognize the parallel device and configure it correctly. The parallel port can also be configured for compatibility with the PS/2 standard.

Docking Connector

The docking connector supports Dell's C/Port Family APR and C/Dock Family Expansion Station docking solutions.

USB Connector

The USB connector supports the use of a USB hub device to attach multiple devices. USB devices are typically low-speed peripherals such as mice, keyboards, printers, and computer speakers. The C/Port APR Family and the C/Dock Expansion Station Family docking solutions have two USB connectors.



NOTE: If you are using a USB external keyboard, do not enter the System Setup program by using a keyboard command on the external keyboard. Instead, press <Fn><F1> on the computer's keyboard.

PS/2 Connector

Use the mini-Deutsche Industrie Norm (DIN) PS/2 connector to attach PS/2-compatible devices such as a mouse, keyboard, or external numeric keypad.



NOTE: If the computer is in suspend mode when you attach a mouse, you can use the mouse when the computer resumes normal operation. Otherwise, you must reboot the computer to use the mouse. While the mouse is attached to the computer, the DualPoint integrated pointing device is disabled.

Serial Connector

To attach a serial device to the computer, use the 9-pin serial connector.

The serial port passes data in serial format (one bit at a time over one line). This port supports a variety of devices that require serial data transmission, including a serial mouse, serial printer, plotter, or external modem.

AC Power Connector

Use the AC power connector to attach the [AC adapter](#) to the computer. The AC adapter converts AC power to the DC power required by the computer.

You can connect the AC adapter with your computer either turned on or off.

The AC adapter works with electrical outlets worldwide. However, power connectors vary among countries. Before using AC power in a foreign country, you may need to obtain a new power cable designed for use in that country.

Infrared Port

The computer's infrared (IR) port is compatible with Infrared Data Association (IrDA) 1.1 (Fast IR) and 1.0 (Slow IR) standards. An infrared port lets you transfer files from your computer to another infrared-compatible device without using cable connections. An infrared data stream is transmitted through a lens in the computer up to a distance of 1 meter (m) (3.3 feet [ft]). This light is received by a compatible computer, printer, mouse, or remote control.

The default address of the infrared port is COM3. To avoid resource conflicts with other devices, remap the address of the infrared port.

When the computer is being used with the C/Port APR Family or C/Dock Expansion Station Family docking solution, the infrared port on the computer is automatically disabled.

Point the computer's infrared port directly at the compatible device's infrared port. Infrared devices transmit data in a 30-degree cone of infrared light. Start the data communications software on both devices, and then begin to transfer files. Read the documentation that came with your compatible device to make sure that you operate it correctly.

For more information about using an infrared device, see the documentation that came with your operating system. The Microsoft Windows NT® 4.0 operating system does not support the use of infrared devices.



NOTES: Make sure that no books, papers, or other objects come between the two infrared devices and that the two devices are within the 30-degree cone.

If the infrared device does not work, the computer and device may be misaligned. Move the device and computer to bring them into the 30-degree cone.

Power Management Settings: Dell™ Latitude™ CPx H-Series/J-Series User's Guide

- [Experimenting With Power Conservation](#)
- [Using Key Combinations with Windows 95, Windows 98, and Windows NT](#)
- [Using Key Combinations with Windows 98 and Windows 2000](#)
- [Closing the Display](#)
- [Suspend Mode](#)
- [Standby Mode](#)
- [Suspend-to-Disk Mode for Windows 95, Windows 98, and Windows NT](#)
- [Hibernate Mode for Windows 98 and Windows 2000](#)
- [Power Management Properties for Microsoft Windows 98](#)
- [Power Management Properties for Microsoft Windows NT](#)
- [Power Options Properties for Microsoft Windows 2000](#)
- [ENERGY STAR Emblem](#)

Experimenting With Power Conservation

In general, the lower the value you set for each power conservation feature, the longer the battery's charge lasts. On the other hand, setting high values tends to optimize the computer's performance.

To evaluate the way that different settings affect how long you can operate the computer on battery power versus the relative efficiency of how the software performs, experiment as follows:

- Use the computer with all the options set at their default values.
- Use the computer with all the options disabled or set to **Off**.
- Use the computer with all the options set to their minimum or maximum values.



*NOTE: For Advanced Configuration and Power Interface (ACPI) compliant systems, power management settings are controlled by the **Power Management or Power Options Properties** in the **Control Panel**. In other systems, power management settings are controlled from the System Setup program.*

Using Key Combinations with Windows 95, Windows 98, and Windows NT

[Table 1](#) identifies the power management key combinations for systems that are APM compliant.



*NOTE: To use key combinations on an external keyboard, enable the **External Hot Key** option in the System Setup program, and press <Scroll Lock> instead of <Fn>.*

Table 1. Key Combinations to Activate/Deactivate Features

| | |
|--|--|
| | |
|--|--|

| Feature | Activate/Deactivate |
|---|---|
| Turn off display | To activate, press <Fn><d>. To deactivate, move the cursor or press a key on the integrated or external keyboard. (If nothing happens, the computer may be in suspend mode. Press the power button to resume normal operation.) |
| Turn off hard-disk drive | To activate, press <Fn><h>. Automatically deactivates when the hard-disk drive is accessed. <i>NOTE: If a modular hard drive is installed in the C/Dock media bay, you cannot turn off the hard-disk drive by pressing <Fn><h>.</i> |
| Suspend mode Standby mode (Windows 98 systems) | To activate, press <Fn><Esc>. To deactivate, press the power button. |
| Suspend-to-disk mode | To activate, press <Fn><a>. (On a French keyboard, press <Fn><q>.) To deactivate, press the power button. |

Using Key Combinations with Windows 98 and Windows 2000

[Table 1](#) identifies the power management key combinations for systems that are ACPI compliant.

 *NOTE: To use key combinations on an external keyboard, enable the **External Hot Key** option in the System Setup program, and press <Scroll Lock> instead of <Fn>.*



 *NOTE: These key combinations function for Advanced Configuration and Power Interface (ACPI) compliant systems.*

Table 1. Key Combinations to Activate/Deactivate Features

| Feature | Activate/Deactivate |
|---|---|
| Sleep mode (ACPI compliant Windows 98 systems) Standby mode (Windows 2000 systems) | To activate, press <Fn><Esc> or the Sleep key on some external keyboards. To deactivate, press the power button. |

 *NOTE: With systems running under ACPI, settings for power management features, such as key combinations and standby or hibernate mode are controlled from the **Power Management** or **Power Options Properties** window in the **Control Panel**. See [Power Management Properties for Windows](#)*

Closing the Display

One way to conserve power on the computer is to close the display when the computer is not in use.

Closing the Display on Windows 95, Windows 98, and Windows NT Systems

When you close the display and an external monitor is *not* connected, the computer's liquid crystal display (LCD) shuts off automatically. If you set the **Display Close** option, in System Setup, to **Suspend**, the computer enters the suspend mode when the display is closed. If you set the **Display Option** to **Active**, the display shuts off when it is closed and does not enter the suspend mode.



NOTE: If an external monitor is connected when you close the display, the computer does not activate suspend mode. You can still use the external monitor.

If the computer detects a wakeup alarm or receives a modem call while the display is closed, the computer handles the alarm or answers the call. After such input/output (I/O) activity ceases, the computer waits 1 minute before reactivating suspend mode.

To resume work, open the display. (The computer may take several seconds to resume operation.)

Closing the Display on Windows 98 and Windows 2000 Systems

When you close the display and an external monitor is *not* connected, the computer's liquid crystal display (LCD) shuts off automatically. You can set the **Display Close** option, in the **Power Management** or **Power Options Properties** window in the **Control Panel** to several selections, such as **Standby**, **Hibernate**, or **Power Off**. The computer performs the specified operation when the display is closed.



NOTE: If an external monitor is connected when you close the display, the computer does not activate a standby or hibernate mode. You can still use the external monitor.

If the computer detects a wakeup alarm or receives a modem call while the display is closed, the computer handles the alarm or answers the call. After such input/output (I/O) activity ceases, the computer waits 1 minute before reactivating the standby or hibernate mode.

To resume work, open the display. (The computer may take several seconds to resume operation.)

Suspend Mode

If your computer is running the Microsoft® Windows® 95 or Microsoft Windows NT® operating system, suspend mode stops almost all computer activity, but leaves the computer ready to resume operations immediately in about 20 to 30 seconds. Use suspend mode whenever you leave the computer unattended.



NOTE: Systems that are ACPI compliant, such as Windows 2000 and some Windows 98 systems do not support suspend mode. ACPI compliant systems support standby mode and hibernate mode. See Microsoft Windows 2000 system help for information on power management settings.

Suspend mode conserves battery power by turning off the microprocessor clock; the display; the hard-disk drive; the CD-ROM, CD-RW, DVD-ROM, or LS-120 drive module (if installed); the external monitor connector; the external keyboard (if attached); the parallel port; the serial port; the touch pad; and the diskette drive.

You can activate suspend mode immediately by pressing <Fn><Esc> (or <Scroll Lock><Esc> on an external keyboard if the **External Hot Key** option is enabled in the System Setup program).

When your system is in suspend mode, the power indicator is not lit.

Resume from suspend mode by pressing the power button. The computer may take several seconds to return to normal operation.



NOTE: On resumption from suspend mode, if a password is set, the system displays the password prompt screen. At the password prompt screen, if you do not enter a password within 2 minutes, the system returns to suspend mode.

Standby Mode

If your computer is running the Microsoft Windows 98 or Windows 2000 operating system, standby mode turns off the display, stops the hard-disk drive, and turns off other internal devices so that the computer uses less battery power. When the computer resumes operation from standby mode, the desktop is restored exactly as it was before entering standby mode.

NOTICE: The computer saves data to random-access memory (RAM), not to your hard-disk drive, before entering standby mode. If the computer enters standby mode while running on battery power, data loss from RAM can occur if the battery discharges completely.

You can activate standby mode by pressing <Fn><Esc>. To resume operation from standby mode, press the power button.



*NOTE: With systems running under ACPI, settings for power management features, such as key combinations and standby mode are controlled from the **Power Management** or **Power Options Properties** window in the **Control Panel**. To activate standby mode, make sure that you have made the appropriate selections from the **Power Management** or **Power Options Properties** window.*

Suspend-to-Disk Mode for Windows 95, Windows 98, and Windows NT

Suspend-to-disk (S2D) mode copies all system data to a reserved area—the S2D partition—on the hard-disk drive and then turns off all power to the computer. When you resume normal operation, the same programs will be running and the same files will be open that were loaded before you activated this mode.



NOTE: Systems that are ACPI compliant, such as Windows 2000 and some Windows 98 systems do not support suspend-to-disk mode. ACPI compliant systems support hibernate mode. See [Hibernate Mode for Windows 98 and Windows 2000](#).

Place the computer in S2D mode if you intend to store the computer for longer than 40 days. S2D mode preserves the configuration information stored in nonvolatile random-access memory (NVRAM). The reserve

battery maintains this information, but it may run out of energy after 40 days.



NOTE: S2D mode helps preserve system data by saving it to the hard-disk drive if you are about to run out of battery power.

To activate S2D, press <Fn><a> (or <Scroll Lock><a> on an external keyboard if the **External Hot Key** option is enabled in the System Setup program). On a French keyboard, press <Fn><q> or <Scroll Lock><q>.

Resume from S2D mode by pressing the power button.

If you connect or remove devices while the computer is in suspend-to-disk mode, the computer automatically recognizes the newly connected devices when it resumes normal operation.

Some PC Cards may not operate correctly after resuming from S2D mode. If you encounter problems with a card, remove and reinsert the card.



*NOTE: Dell creates an appropriately sized S2D partition before shipping the computer to you. Use the Suspend-to-Disk utility to remove the file, to increase the size of the file, or to add the suspend-to-disk file if you removed it. For more information about altering or creating a suspend-to-disk file, see the **readme.S2D** file, which can be found in the **Dell Utilities** folder on your hard-disk drive or on the S2D diskette that came with your computer. In Windows 95 and Windows 98 operating systems do not use the Add/Remove Devices option while in S2D mode unless Bay Manager is installed.*

Hibernate Mode for Windows 98 and Windows 2000

Through the **Power Options Properties** in the **Control Panel** for ACPI compliant systems, you can enable the computer's hibernate mode.

Hibernate mode copies everything in memory to the hard-disk drive and then turns off all power to the computer. When you resume normal operation, the same programs will be running and the same files will be open that were loaded before you activated this mode.

Place the computer in hibernate mode if you intend to store the computer for extended periods of time. Hibernate mode preserves the configuration information stored in nonvolatile random-access memory (NVRAM).



NOTE: Hibernate mode helps preserve system data by saving it to the hard-disk drive if you are about to run out of battery power.

To enable the hibernate mode:

1. Click the **Start** button. Point to **Settings** and then **Control Panel**.
2. Double-click the **Power Options** icon.

The **Power Options Properties** window appears.

3. Click the **Hibernate** tab.

4. Select **Enable Hibernate Support**.
5. Click **Apply**.
6. Click the **Advanced** tab.

Select **Hibernate** for each of the appropriate options listed under the **Advanced** tab.

7. Click **Apply**.

When you shut down your computer, you will see a new option in the **Start** menu called **Hibernate**. See Microsoft Windows 2000 system help for more information on hibernate mode.

Resume from hibernate mode by pressing the power button.



NOTE: With systems running ACPI, you cannot remove devices or undock your computer while in the hibernate mode.

Some PC Cards may not operate correctly after resuming from hibernate mode. If you encounter problems with a card, remove and reinsert the card.

Power Management Properties for Microsoft Windows 98

Windows 98 with Advanced Power Management (APM) provides the **Power Management Properties** window for setting power conservation features.

To access the **Power Management Properties** window and set the power management features, perform the following steps in Windows 98:

1. Click the **Start** button, point to **Settings**, and click **Control Panel**.
2. Double-click the **Power Management Properties** icon.

The **Power Management Properties** window contains the following tabs:

- **Power Scheme** — allows you to select one of three power mode settings.



*NOTE: With systems running ACPI, select the **Notebook/Portable** setting as the **Power Scheme** to conserve battery life while the system is in standby mode. If the **Always On** setting is selected, the battery life may be much shorter when in standby mode.*

- **Alarms** — allows you to set the **Low Battery** and **Critical Battery** alarms to alert you when the computer battery falls below a certain percentage. When you received your computer, the **Low Battery** and **Critical Battery** alarms check boxes were not checked. Dell recommends that you do not select these options.
- **Power Meter** — allows you to view the percentage of battery life remaining when your computer is operating on battery power. If your computer is operating on AC power, the computer displays a message.

- **Advanced** — allows you to display the **Power Meter** on the Windows 98 taskbar and to display a password prompt when the computer resumes from standby mode.
 - **Hibernate (ACPI only)** — allows you to enable the hibernate feature.
-

Power Management Properties for Microsoft Windows NT

Dell provides Softex software compatible with the Power Management Controller, which allows you to suspend and resume your portable computer without affecting your ability to use the docking station or its media bay.

For information about Softex power management software, see the Softex user's guides at <http://www.dell.com/>. Select **Small Business Center** or **Medium & Large Business**. Select **Latitude**. Then select **Notebooks**. Look for the *Softex Utilities Installation Guide* on the left of the screen. Also, see your *Dell-Installed Microsoft Windows NT Workstation Setup Guide*.

Power Options Properties for Microsoft Windows 2000

Windows 2000 with ACPI provides the **Power Options Properties** window for setting power conservation features. With the **Power Options Properties** in the **Control Panel**, you can adjust the power management options supported by your computer's hardware configuration. By allowing you to create your own power schemes, the power options feature allows you to reduce the power consumption of your computer devices

To access the **Power Options Properties** window and set the power management features, perform the following steps in Windows 2000:

1. Click the **Start** button, point to **Settings**, and click **Control Panel**.
2. Double-click the **Power Options Properties** icon.

The **Power Options Properties** window contains the following tabs:

- **Power Scheme** — allows you to select one of three power mode settings.



*NOTE: With systems running ACPI, select the **Notebook/Portable** setting as the **Power Scheme** to conserve battery life while the system is in standby mode. If the **Always On** setting is selected, the battery life may be much shorter when in standby mode.*

- **Alarms** — allows you to set the **Low Battery** and **Critical Battery** alarms to alert you when the computer battery falls below a certain percentage. When you received your computer, the **Low Battery** and **Critical Battery** alarms check boxes were not checked. Dell recommends that you do not select these options.
- **Power Meter** — allows you to view the percentage of battery life remaining when your computer is operating on battery power.
- **Advanced** — allows you to specify the actions (standby, hibernate, or power off) of the

power button, the sleep button, and closing the display. You can enable the hibernate mode through the **Advanced** tab.

- **Hibernate (ACPI only)** — allows you to enable the hibernate feature.

See Microsoft *Windows 2000 Help* for more information on **Power Options Properties**.

ENERGY STAR[®] Emblem



The EPA's ENERGY STAR[®] Computers program is a joint effort between the EPA and computer manufacturers to reduce air pollution by promoting energy-efficient computer products. The EPA estimates that use of ENERGY STAR[®] computer products can save computer users up to two billion dollars annually in electricity costs.

[Back to Contents Page](#)

Installing the Microsoft® Windows® 95 and Windows 98 Operating System Drivers: Dell™ Latitude™ CPx H-Series/J-Series User's Guide

- [Overview](#)
- [Installing Operating System Updates](#)
- [Installing Docking Drivers](#)
- [Installing Video Drivers](#)
- [Installing Audio Drivers](#)
- [Installing DualPoint Integrated Pointing Device Drivers](#)
- [Installing Softex BayManager Software](#)
- [Installing MS-DOS CD-ROM Drivers](#)
- [Enabling Microsoft Infrared Support](#)
- [Installing Infrared Drivers](#)
- [Installing System Utilities](#)
- [Installing Intel SpeedStep Utility](#)

Overview

Dell provides software utilities and drivers that help you control certain features of your computer.

This section explains how to use your *System Software* CD to reinstall utilities and drivers on your Dell computer with the Microsoft Windows 95 or Windows 98 operating system. You may need administrator privileges to perform some of the procedures in this section. Dell recommends that you check with your network administrator before performing the procedures.



NOTE: Your System Software CD contains drivers for operating systems that may not be on your computer. Verify that the driver you are loading is under your operating system subdirectory. For example, if you want to install video drivers for a system running Windows 98, look under \drivers\win98\video.

Dell recommends that you print these procedures before you begin.



*NOTE: For more information on using the operating system installed on your computer by Dell, see the operating system user's guide that came with your computer. You can also access system tools and documentation from Dell's technical support page at <http://support.dell.com>. Click the map that appears to select your country and the **Welcome to support.dell.com** page opens. Enter your system information to access help tools and information.*

NOTICE: Do not dock the computer before turning it on the first time.

Installing Operating System Updates

Dell provides operating system updates that are enhancements to the operating system specific to your Dell portable computer. To install the operating system updates, perform the following steps:

1. Save your work in all open application programs, because you will need to restart your computer at the end of this procedure to complete the installation.
 2. Insert the *System Software* CD into the drive.
 3. Click the **Start** button, then click **Run...**
The **Run** dialog box appears.
 4. Click the **Browse** button.
 5. Select the appropriate drive for your CD-ROM.
 6. Locate the **setup.exe** file for the operating system updates for your specific operating system. For example, if you want to install operating system updates for a system running Windows 98, look under \win98\osupdate\setup.
 7. Click **OK** or press <Enter>.
 8. Follow the instructions on your display.
 9. After the files are copied to your hard-disk drive, click **Finish** to restart your computer.
-

Installing Docking Drivers



NOTE: If your computer uses Windows 95 or Windows 98, the computer is already configured to work with the Dell Latitude C/Port Family Advanced Port Replicator (APR) or C/Dock Family Expansion Station.

To successfully install docking drivers for your computer, you must run the Dock QuickInstall program before you install the docking drivers.

Running Dock QuickInstall

To run Dock QuickInstall, perform the following steps:

1. *If the computer has never been turned on*, turn it on now while it is undocked and complete the operating system setup. Then go to step 2.

For setup instructions, see the Dell-supplied operating system setup guide that came with the computer.

2. Save your work in all open application programs, because you will need to restart your computer at the end of this procedure to complete the installation.
3. Insert the *System Software* CD into the drive.

4. Click the **Start** button, then click **Run...**

The **Run** dialog box appears.

5. Click the **Browse** button.
6. Select the appropriate drive for your CD-ROM.
7. Locate the **setup.exe** file for the Dock QuickInstall program for your specific operating system. For example, if you want to install Dock QuickInstall for a system running Windows 98, look under `\win98\dockquik\setup`.
8. Click **OK** or press <Enter>.
9. Follow the instructions on your display.
10. After the files are copied to your hard-disk drive, click **Finish** to restart your computer.

Installing Docking Drivers

To install the C/Port Family APR or C/Dock Family Expansion Station drivers, perform the following steps:

1. *If you have completed the operating system setup*, turn on the computer, and then go to step 2.
2. Dock the computer.

The operating system creates a hardware profile for the C/Port APR or the C/Dock Expansion Station.

3. To load the appropriate drivers for use with the C/Port APR or C/Dock Expansion Station, follow the instructions on the display. When prompted, restart the computer.
4. Install the appropriate drivers to use with a network expansion card in the C/Dock Expansion Station.

Installing Video Drivers

Video drivers control features such as screen resolution and the number of screen colors.



NOTE: If you need to use extended video modes, check the documentation that came with the application program to determine if the drivers are provided. If not, contact the software manufacturer to get the necessary drivers.

To install the video drivers, perform the following steps:

1. Save your work in all open application programs, because you will need to restart your computer at the end of this procedure to complete the installation.
2. Insert the *System Software* CD into the drive.
3. Click the **Start** button, then click **Run**.

The **Run** dialog box appears.

4. Click the **Browse** button.
5. Select the appropriate drive for your CD-ROM.
6. Locate the **setup.exe** file for the video driver for your specific operating system. For example, if you want to install video drivers for a system running Windows 98, look under \win98\video\setup.
7. Click **OK** or press <Enter>.
8. Follow the instructions on your display.
9. After the files are copied to your hard-disk drive, click **Finish** to restart your computer.

After installing the video drivers and restarting your computer, perform the following steps to set the display parameters:

1. Click the **Start** button, point to **Settings**, and then click **Control Panel**.

The **Control Panel** window appears.

2. Double-click the **Display** icon.

The **Display Properties** window appears.

3. Click the **Settings** tab.
4. Change the **Color Palette** or **Colors** option to **True Color (24 bit)**.
5. Set the **Screen** area for your display to the appropriate size.
6. Click **Apply**.

Installing Audio Drivers

Dell provides audio drivers so you can customize the audio features of your computer. To install the audio drivers, perform the following steps:

1. Save your work in all open application programs, because you will need to restart your computer at the end of this procedure to complete the installation.
2. Insert the *System Software* CD into the drive.
3. Click the **Start** button, then click **Run...**

The **Run** dialog box appears.

4. Click the **Browse** button.

5. Select the appropriate drive for your CD-ROM.
 6. Locate the **setup.exe** file for the audio driver for your specific operating system. For example, if you want to install audio drivers for a system running Windows 98, look under \win98\audio\setup.
 7. Click **OK** or press <Enter>.
 8. Follow the instructions on your display.
 9. After the files are copied to your hard-disk drive, click **Finish** to restart your computer.
-

Installing DualPoint Integrated Pointing Device Drivers

DualPoint integrated pointing device drivers and associated utilities allow you to use and customize the integrated touch pad, track stick, or an external mouse. To install these drivers, perform the following steps:

1. Save your work in all open application programs, because you will need to restart your computer at the end of this procedure to complete the installation.
2. Insert the *System Software* CD into the drive.
3. Click the **Start** button, then click **Run...**

The **Run** dialog box appears.

4. Click the **Browse** button.
 5. Select the appropriate drive for your CD-ROM.
 6. Locate the **setup.exe** file for the DualPoint integrated pointing device driver for your specific operating system.
 7. Click **OK** or press <Enter>.
 8. Follow the instructions on your display.
 9. After the files are copied to your hard-disk drive, click **Finish** to restart your computer.
 10. Restart your computer to activate the DualPoint integrated pointing device drivers.
-

Installing Softex BayManager Software

Dell provides Softex BayManager software that contains support for the following features:

- Hot-swapping devices such as diskette drives, hard-disk drives, large-storage drives, DVD-ROM drives, and CD-ROM drives to and from your portable computer's modular bay and the C/Dock Family Expansion Station's media bay
- Docking services that are available in French, German, Italian, Spanish, and Japanese

To install the BayManager application program from the *System Software* CD, perform the following steps:

1. Save your work in all open application programs, because you will need to restart your computer at the end of this procedure to complete the installation.
2. Insert the *System Software* CD into the drive.
3. Click the **Start** button, then click **Run...**

The **Run** dialog box appears.

4. Type `x:\win95\baymgr\setup.exe` or `x:\win98\baymgr\setup.exe` (depending on your operating system, and where *x* is your CD-ROM drive designator).
 5. Click **OK** or press <Enter>.
 6. Follow the instructions on your display.
 7. After the files are copied to your hard-disk drive, click **Finish** to restart your computer.
 8. Restart your computer to activate the BayManager software.
-

Installing MS-DOS® CD-ROM Drivers

CD-ROM drivers must be installed in order to use the MS-DOS CD-ROM utility. To install the CD-ROM drivers, perform the following steps:

1. Save your work in all open application programs, because you will need to restart your computer at the end of this procedure to complete the installation.
2. Insert the *System Software* CD into the drive.
3. Click the **Start** button, then click **Run....**

The **Run** dialog box appears.

4. Click the **Browse** button.
 5. Select the appropriate drive for your CD-ROM.
 6. Locate the **setup.exe** file for the MS-DOS CD-ROM driver for your specific operating system.
 7. Click **OK** or press <Enter>.
 8. Follow the instructions on your display.
 9. After the files are copied to your hard-disk drive, click **Finish** to restart your computer.
-

Enabling Microsoft Infrared Support

For Windows 95, you must install the infrared drivers before you can enable them (Windows 98 already includes infrared support). You must enable Microsoft infrared support for both Windows 95 and Windows 98 before you can use it. To enable Microsoft infrared support, perform the following steps:

1. Click the **Start** button, point to **Settings**, and then click **Control Panel**.
2. Double-click the **Add New Hardware** icon.

The **Add New Hardware Wizard** appears.

3. Click **Next** to continue.



*NOTE: If the infrared device is not listed, click **No**, then click **Next**.*

4. When the **Add New Hardware Wizard** asks to search for new hardware, click **No** and then click **Next**.
5. When the **Hardware Types** window appears, click the **Infrared** tab and then click **Next**.
6. When the **Add Infrared Device Wizard** window appears, click **Next**. If you are using Windows 98, go to Step 8.
7. In Windows 95, when the **Manufacturers and Models** window appears, select **Standard Infrared Devices** from the **Manufacturers** list and **Built-In Infrared Port on Laptop or Desktop** from the **Models** list, and then click **Next**.
8. To complete this portion of the installation, follow the instructions on your display.
9. To enable infrared support, shut down and reboot your computer.
10. If you are using Windows 98, the process is complete. If you are using Windows 95, complete the procedure in "[Installing Infrared Drivers](#)."

Installing Infrared Drivers

The infrared port lets you transfer files from your computer to another infrared-compatible device without using cable connections.



NOTE: To use the infrared port, Windows 95 users must install the infrared drivers and then enable them. Windows 98 already includes the necessary drivers; Windows 98 users need only enable the infrared support.

If your computer is running the Microsoft Windows 95 operating system, install the infrared drivers by performing the following steps:

1. Save your work in all open application programs, because you will need to restart your computer at the end of this procedure to complete the installation.
2. Insert the *System Software* CD containing the *Infrared Drivers* into the drive.

3. Click the **Start** button, point to **Settings**, and then click **Control Panel**.

4. Double-click the **System** icon.

The **System Properties** dialog box appears.

5. Click the **Device Manager** tab.

6. Click the **View Devices by Type** button.

7. Click the plus sign to the left of the **Ports** icon.

The names of various device ports appear beneath the **Ports** icon.

8. Click **Infrared Serial (COM) Connections Port**, and then click **Properties**.

The **Infrared Serial (COM) Connections Port Properties** dialog box appears.

9. Click the **Driver** tab and **Update Driver**.

The **Update Device Driver Wizard** appears.

10. Click the **Yes (Recommended)** button, and then click **Next**.

The system searches for the drivers on the CD you inserted in step 2.

11. To complete the installation, follow the instructions on your display .

12. After the driver is updated, close the **Device Manager** and open **Windows Explorer**.

13. With the CD still in the drive, click **drive X**, where **X** is the CD-ROM drive.

14. Right-click the **smcirlap.inf** file.

A pop-up menu appears.

15. Click **Install**.

The **smcirlap.inf** file is installed.

16. Restart your computer to activate the infrared drivers.

Installing System Utilities

System utilities let you configure features such as the asset tag code and suspend-to-disk partition. To copy the system utilities to your hard-disk drive, perform the following steps.



NOTE: You can also run the system utilities directly from the System Software CD.

1. Insert the *System Software* CD into the drive.

2. Click the **Start** button, then click **Run...**

The **Run** dialog box appears.

3. Click the **Browse** button.
4. Select the appropriate drive for your CD-ROM.
5. Locate the **setup.exe** file for the system utilities for your specific operating system.
6. Click **OK** or press <Enter>.
7. Follow the instructions on your display.
8. Copy each of the utilities on the *System Software* CD to the **c:\dell** directory on your hard-disk drive. The utilities have filenames, such as: **mks2d.exe**, **rms2d.exe**, **asset.com**, and **readme.s2d**.
9. After the files are copied to your hard-disk drive, click **Finish** to restart your computer.

For more information on copying files, see the documentation that came with the operating system.

After you copy the utilities to your hard-disk drive, you must restart your computer in the MS-DOS mode to use the utilities.

See the **readme.s2d** file for more information on using the suspend-to-disk partition utilities. For more information on using the asset tag utility, see your Dell computer documentation.

Installing the Intel® SpeedStep™ Utility

Intel SpeedStep technology conserves battery power by automatically adjusting the processor speed when you run your computer from the battery instead of AC power. Intel SpeedStep reduces the processor speed when using the battery and resumes maximum processor speed when plugged into an electrical outlet.

 **NOTE:** This utility is available only for CPx J-Series systems.

To install Intel SpeedStep, perform the following steps:

1. Insert the *System Software* CD into the CD-ROM drive.
2. Click the **Start** button, and then click **Run**.
3. The **Run** dialog box appears.
4. Type **x:\win98\speedstp\language\setup**, where *x* is the drive letter of your CD-ROM drive and *language* is *English*, *Japanese*, or *Other*, and then click **OK** or press <Enter>.
5. Follow the instructions on the screen.

6. After the files are copied to your hard-disk drive, click **Finish** to restart your computer.

[Back to Contents Page](#)

Installing the Microsoft® Windows NT® Operating System Drivers: Dell™ Latitude™ CPx H-Series/J-Series User's Guide

- [Overview](#)
- [Installing Operating System Updates](#)
- [Installing Video Drivers](#)
- [Installing the Power Management Utility](#)
- [Installing Softex Docking Services](#)
- [Installing the PC Card Utility](#)
- [Installing Audio Drivers](#)
- [Installing DualPoint Integrated Pointing Device Drivers](#)
- [Installing MS-DOS CD-ROM Drivers](#)
- [Installing System Utilities](#)
- [Installing Intel SpeedStep Utility](#)

Overview

Dell provides software utilities and drivers that help you control certain features of your computer.

This section explains how to use your *System Software* CD to reinstall utilities and drivers on your Dell computer with the Microsoft Windows NT 4.0 operating system. You may need administrator privileges to perform some of the procedures in this section. Dell recommends that you check with your network administrator before performing the procedures.



NOTE: Your System Software CD contains drivers for operating systems that may not be on your computer. Verify that the driver you are loading is under your operating system subdirectory. For example, if you want to install video drivers for a system running Windows NT, look under \winNT\video.

Dell recommends that you print these procedures before you begin.



*NOTE: For more information on using the operating system installed on your computer by Dell, see the operating system user's guide that came with your computer. You can also access system tools and documentation from Dell's technical support page at <http://support.dell.com>. Click the map that appears to select your country and the **Welcome to support.dell.com** page opens. Enter your system information to access help tools and information.*

Installing Operating System Updates

Dell provides operating system updates that are enhancements to the operating system specific to your Dell portable computer. To install the operating system updates, perform the following steps:

1. Save your work in all open application programs, because you will need to restart your computer at the end of this procedure to complete the installation.

2. Insert the *System Software* CD into the drive.
 3. Click the **Start** button, then click **Run...**
The **Run** dialog box appears.
 4. Click the **Browse** button.
 5. Select the appropriate drive for your CD-ROM.
 6. Locate the **setup.exe** file for the operating system updates for your specific operating system. For example, if you want to install operating system updates for a system running Windows NT, look under \winNT\osupdate\setup.
 7. Click **OK** or press <Enter>.
 8. Follow the instructions on your display.
 9. After the files are copied to your hard-disk drive, click **Finish** to restart your computer.
-

Installing Video Drivers

Video drivers control features such as screen resolution and the number of screen colors.



NOTE: If you need to use extended video modes, check the documentation that came with the application program to determine if the drivers are provided. If not, contact the software manufacturer to get the necessary drivers.

To install the video drivers for Windows NT 4.0, perform the following steps:

1. Save your work in all open application programs, because you will need to restart your computer at the end of this procedure to complete the installation.
2. Insert the *System Software* CD into the drive.
3. Click the **Start** button, then click **Run**.
The **Run** dialog box appears.
4. Click the **Browse** button.
5. Select the appropriate drive for your CD-ROM.
6. Locate the **setup.exe** file for the video drivers for your specific operating system. For example, if you want to install video drivers for a system running Windows NT, look under \winNT\video\setup.
7. Click **OK** or press <Enter>.
8. Follow the instructions on your display.

9. After the files are copied to your hard-disk drive, click **Finish** to restart your computer.

After installing the video drivers and restarting your computer, perform the following steps to set the display parameters.

1. Click the **Start** button, point to **Settings**, and then click **Control Panel**.

The **Control Panel** window appears.

2. Double-click the **Display** icon.

The **Display Properties** window appears.

3. Click the **Settings** tab.
4. Change the **Colors** option to **True Color (24 bit)**.
5. Set the **Screen** area for your display to the appropriate size.
6. Click **Apply**.

Installing the Power Management Utility

Dell provides a power management utility that helps you conserve battery power and view available power levels. To install the power management utility, perform the following steps:

1. Save your work in all open application programs, because you will need to restart your computer at the end of this procedure to complete the installation.
2. Insert the Dell *System Software* CD into the the CD-ROM drive.
3. Click the **Start** button, and then click **Run...**

The **Run** dialog box appears.

4. Click the **Browse** button.
5. Select the appropriate drive for your CD-ROM.
6. Locate the **setup.exe** file for the power management utility for your specific operating system. For example, if you want to install power management utilities for a system running Windows NT, look under `\winNT\powermgt\setup`.
7. Follow the instructions on the display.
8. When prompted, restart your computer to activate the utility.

Installing Softex Docking Services

Dell provides Softex Docking Services software that contains support for the following features:

- Hot-docking and warm-undocking a Latitude portable computer from supported docking stations
- Hot-swapping devices such as diskette drives, hard-disk drives, large-storage drives, DVD-ROM drives, and CD-ROM drives to and from your portable computer's modular bay and the C/Dock Family Expansion Station's media bay
- Compatibility with the Power Management Controller, which allows you to suspend and resume your portable computer without affecting your ability to use the docking station or its media bay
- Docking or undocking your portable computer while it is in suspend mode
- Docking services available in French, German, Italian, Spanish, and Japanese

For the latest information on Softex Docking Services, see the Softex user's guides at <http://www.dell.com/>. Click **Small Business Center** or **Medium & Large Business**. Click **Notebooks**; then, if applicable, click **Latitude**. Look for the *Softex Utilities Installation Guide* on the left of the screen.

To install Softex Docking Services from the System Software CD, perform the following steps:

1. Save your work in all open application programs, because you will need to restart your computer at the end of this procedure to complete the installation.
2. Insert the Dell *System Software* CD into the the CD-ROM drive.
3. Click the **Start** button, and then click **Run...**
The **Run** dialog box appears.
4. Type `x:\winnt4\docking\setup.exe` (where *x* is your CD-ROM drive designator).
5. Click **OK** or press <Enter>.
6. Follow the instructions on the display.
7. When prompted, restart your computer to activate the utility.

Installing the PC Card Utility

Dell provides a PC Card utility that allows you to view and configure settings for your PC Card(s). To install the PC Card utility, perform the following steps:

1. Save your work in all open application programs, because you will need to restart your computer at the end of this procedure to complete the installation.
2. Insert the *System Software* CD into the CD-ROM drive.
3. Click the **Start** button, and then click **Run...**

The **Run** dialog box appears.

4. Click the **Browse** button.
 5. Select the appropriate drive for your CD-ROM.
 6. Locate the **setup.exe** file for the PC Card utility for your specific operating system. For example, if you want to install the PC Card utility for a system running Windows NT, look under \winNT\pccard\setup.
 7. Follow the instructions on your display.
 8. When the computer completes the starting sequence, the **Softex PC Card Controller Diagnostics** window appears.
 9. Follow the instructions on your display, and when prompted, restart your computer to activate the utility.
-

Installing Audio Drivers

Dell provides audio drivers so you can customize the sound features of your computer.

To install the audio drivers, perform the following steps:

1. Save your work in all open application programs, because you will need to restart your computer at the end of this procedure to complete the installation.
2. Insert the *System Software* CD into the CD-ROM drive.
3. Click the **Start** button, then click **Run....**

The **Run** dialog box appears.

4. Click the **Browse** button.
 5. Select the appropriate drive for your CD-ROM.
 6. Locate the **setup.exe** file for the audio driver for your specific operating system. For example, if you want to install audio drivers for a system running Windows NT, look under \winNT\audio\setup.
 7. Click **OK** or press <Enter>.
 8. Follow the instructions on your display.
 9. After the files are copied to your hard-disk drive, click **Finish** to restart your computer.
-

Installing DualPoint Integrated Pointing Device Drivers

DualPoint integrated pointing device drivers and associated utilities allow you to use and customize the integrated touch pad, track stick, or an external mouse. To install these drivers, perform the following steps:

1. Save your work in all open application programs, because you will need to restart your computer at the

end of this procedure to complete the installation.

2. Insert the *System Software* CD into the CD-ROM drive.
3. Click the **Start** button, then click **Run....**

The **Run** dialog box appears.

4. Click the **Browse** button.
 5. Select the appropriate drive for your CD-ROM.
 6. Locate the **setup.exe** file for the DualPoint integrated pointing device driver for your specific operating system. For example, if you want to install DualPoint integrated pointing device drivers for a system running Windows NT, look under \winNT\touch\setup.
 7. Click **OK** or press <Enter>.
 8. Follow the instructions on your display.
 9. After the files are copied to your hard-disk drive, click **Finish**.
 10. Restart your computer to activate the DualPoint integrated pointing device drivers.
-

Installing MS-DOS® CD-ROM Drivers

CD-ROM drivers must be installed in order to use the MS-DOS CD-ROM utility. To install the CD-ROM drivers, perform the following steps:

1. Save your work in all open application programs, because you will need to restart your computer at the end of this procedure to complete the installation.
2. Insert the *System Software* CD into the CD-ROM drive.
3. Click the **Start** button, then click **Run....**

The **Run** dialog box appears.

4. Click the **Browse** button.
5. Select the appropriate drive for your CD-ROM.
6. Locate the **setup.exe** file for the MS-DOS CD-ROM driver for your specific operating system. For example, if you want to install MD-DOS CD-ROM drivers for a system running Windows NT, look under \winNT\cdrom\setup.
7. Click **OK** or press <Enter>.
8. Follow the instructions on your display.

9. After the files are copied to your hard-disk drive, click **Finish** to restart your computer.
-

Installing System Utilities

System utilities let you configure features such as the asset tag code and suspend-to-disk partition. To copy the system utilities to your hard-disk drive, perform the following steps.



NOTE: You can also run the system utilities directly from the System Software CD or diskette.

1. Insert the *System Software* CD into the drive.
2. Click the **Start** button, then click **Run...**
The **Run** dialog box appears.
3. Click the **Browse** button.
4. Select the appropriate drive for your CD-ROM.
5. Locate the **setup.exe** file for the system utilities for your specific operating system.
6. Click **OK** or press <Enter>.
7. Follow the instructions on your display.
8. Copy each of the utilities on the *System Software* CD to the **c:\dell** directory on your hard-disk drive. The utilities have the following filenames: **mks2d.exe**, **rms2d.exe**, **asset.com**, and **readme.s2d**.
9. After the files are copied to your hard-disk drive, click **Finish** to restart your computer.

For more information on copying files, see the documentation that came with the operating system.

After you copy the utilities to your hard-disk drive, you must restart your computer in the MS-DOS® mode to use the utilities. Restart your computer in the MS-DOS mode by booting from the *System Software* CD.

See the **readme.s2d** file for more information on using the suspend-to-disk partition utilities. For more information on using the asset tag utility, see your Dell computer documentation.

Installing the Intel® SpeedStep™ Utility

Intel SpeedStep technology conserves battery power by automatically adjusting the processor speed when you run your computer from the battery instead of AC power. Intel SpeedStep reduces the processor speed when using the battery and resumes maximum processor speed when plugged into an electrical outlet.



NOTE: This utility is available only for CPx J-Series systems.

To install Intel SpeedStep, perform the following steps:

1. Insert the *System Software* CD into the CD-ROM drive.
 2. Click the **Start** button, and then click **Run**.
 3. The **Run** dialog box appears.
 4. Type `x:\winnt4\speedstp\language\setup`, where *x* is the drive letter of your CD-ROM drive and *language* is *English*, *Japanese*, or *Other*, and then click **OK** or press <Enter>.
 5. Follow the instructions on the screen.
 6. After the files are copied to your hard-disk drive, click **Finish** to restart your computer.
-

[Back to Contents Page](#)

Installing the Microsoft® Windows® 2000 Operating System Drivers: Dell™ Latitude™ CPx H-Series/J-Series User's Guide

 [Overview](#)

 [Installing Video Drivers](#)

 [Installing Audio Drivers](#)

 [Installing DualPoint Integrated Pointing Device Drivers](#)

 [Installing MS-DOS CD-ROM Drivers](#)

 [Installing MS-DOS CD-ROM Drivers](#)

 [Installing Intel SpeedStep Utility](#)

Overview

Dell provides software utilities and drivers that help you control certain features of your computer.

This section explains how to use your *System Software* CD to reinstall drivers on your Dell computer with the Microsoft Windows 2000 operating system. You may need administrator privileges to perform some of the procedures in this section. Dell recommends that you check with your network administrator before performing the procedures.



*NOTE: Your System Software CD contains drivers for operating systems that may not be on your computer. Verify that the driver you are loading is under your operating system subdirectory. For example, if you want to install video drivers for a system running Windows 2000, look under **win2000\video**.*

Dell recommends that you print these procedures before you begin.



*NOTE: For more information on using the operating system installed on your computer by Dell, see the operating system user's guide that came with your computer. You can also access system tools and documentation from Dell's technical support page at **http://support.dell.com**. Click the map that appears to select your country and the **Welcome to support.dell.com** page opens. Enter your system information to access help tools and information.*

Installing Video Drivers

Video drivers control features such as screen resolution and the number of screen colors.



NOTE: If you need to use extended video modes, check the documentation that came with the application program to determine if the drivers are provided. If not, contact the software manufacturer to get the necessary drivers.

To install the video drivers for Windows 2000, perform the following steps:

1. Save your work in all open application programs, because you will need to restart your computer at the

end of this procedure to complete the installation.

2. Insert the *System Software* CD into the drive.
3. Click the **Start** button, then click **Run**.

The **Run** dialog box appears.

4. Type `x:\win2000\video\setup.exe` (where *x* is your CD-ROM drive designator).
5. Click **OK** or press <Enter>.
6. Follow the instructions on your display.
7. After the files are copied to your hard-disk drive, click **Finish** to restart your computer.

After installing the video drivers and restarting your computer, perform the following steps to set the display parameters.

1. Click the **Start** button, point to **Settings**, and then click **Control Panel**.

The **Control Panel** window appears.

2. Double-click the **Display** icon.

The **Display Properties** window appears.

3. Click the **Settings** tab.
4. Change the **Colors** option to True Color or 24 bit.
5. Set the **Screen** area for your display to the appropriate size.
6. Click **OK**.

Installing Audio Drivers

Dell provides audio drivers so you can customize the sound features of your computer.



NOTE: When you install the audio drivers, the drivers for the internal modem (if present) are installed automatically. If no modem is installed in your system, the modem drivers will not be installed.

To install the audio drivers, perform the following steps:

1. Save your work in all open application programs, because you will need to restart your computer at the end of this procedure to complete the installation.
2. Insert the *System Software* CD into the CD-ROM drive.
3. Click the **Start** button, then click **Run....**

The **Run** dialog box appears.

4. Type `x:\win2000\audio\setup.exe` (where *x* is your CD-ROM drive designator).
 5. Click **OK** or press <Enter>.
 6. Follow the instructions on your display.
 7. After the files are copied to your hard-disk drive, click **Finish** to restart your computer.
-

Installing DualPoint Integrated Pointing Device Drivers

DualPoint integrated pointing device drivers and associated utilities allow you to use and customize the integrated touch pad, track stick, or an external mouse. To install these drivers, perform the following steps:

1. Save your work in all open application programs, because you will need to restart your computer at the end of this procedure to complete the installation.
2. Insert the *System Software* CD into the CD-ROM drive.
3. Click the **Start** button, then click **Run....**

The **Run** dialog box appears.

4. Type `x:\win2000\touchpad\setup.exe` (where *x* is your CD-ROM drive designator).
 5. Click **OK** or press <Enter>.
 6. Follow the instructions on your display.
 7. After the files are copied to your hard-disk drive, click **Finish**.
 8. Restart your computer to activate the DualPoint integrated pointing device drivers.
-

Installing MS-DOS® CD-ROM Drivers

CD-ROM drivers must be installed in order to use the MS-DOS CD-ROM utility. To install the CD-ROM drivers, perform the following steps:

1. Save your work in all open application programs, because you will need to restart your computer at the end of this procedure to complete the installation.
2. Insert the *System Software* CD into the CD-ROM drive.
3. Click the **Start** button, then click **Run....**

The **Run** dialog box appears.

4. Type `x:\win2000\cdrom\setup.exe` (where *x* is your CD-ROM drive designator).

5. Click **OK** or press <Enter>.
 6. Follow the instructions on your display.
 7. After the files are copied to your hard-disk drive, click **Finish** to restart your computer.
-

Installing the Intel® SpeedStep™ Utility

Intel SpeedStep technology conserves battery power by automatically adjusting the processor speed when you run your computer from the battery instead of AC power. Intel SpeedStep reduces the processor speed when using the battery and resumes maximum processor speed when plugged into an electrical outlet.

 **NOTE:** This utility is available only for CPx J-Series systems.

To install Intel SpeedStep, perform the following steps:

1. Insert the *System Software* CD into the CD-ROM drive.
 2. Click the **Start** button, and then click **Run**.
 3. The **Run** dialog box appears.
 4. Type `x:\win2000\speedstp\language\setup`, where *x* is the drive letter of your CD-ROM drive and *language* is *English*, *Japanese*, or *Other*, and then click **OK** or press <Enter>.
 5. Follow the instructions on the screen.
 6. After the files are copied to your hard-disk drive, click **Finish** to restart your computer.
-

[Back to Contents Page](#)

System Setup Options: Dell™ Latitude™ CPx H-Series/J-Series User's Guide

- [AC](#)
- [Admin Password](#)
- [Alarm Resume](#)
- [Asset Tag](#)
- [Audio Mode](#)
- [Battery](#)
- [Battery Status](#)
- [BIOS Version](#)
- [Boot First Device](#)
- [Boot Second Device](#)
- [Boot Speed](#)
- [Brightness](#)
- [Click Volume](#)
- [Configure Setup](#)
- [CPU Serial Number](#)
- [Date](#)
- [Disk Time-Out](#)
- [Diskette Drive A](#)
- [Diskette Drive B](#)
- [Diskette Reconfig](#)
- [Display Close](#)
- [Display Time-out](#)
- [Docking Ethernet](#)
- [Docking IRQ](#)
- [Docking Status](#)
- [External Hot Key](#)
- [Hard-disk Drive Password](#)
- [Infrared Data Port](#)
- [Infrared Mode](#)
- [Keyboard Click](#)
- [Level 2 Cache](#)
- [Modular Bay](#)
- [Microprocessor](#)
- [Num Lock](#)
- [Parallel Mode](#)
- [Pointing Device](#)
- [Power Management](#)
- [Primary Hard Drive](#)
- [Primary Password](#)
- [Ring/Event Resume](#)
- [S2D Time-out](#)
- [Serial Port](#)
- [Service Tag](#)
- [Smart CPU Mode](#)
- [Intel SpeedStep Setup](#)
- [Suspend Time-out](#)
- [System Memory](#)
- [System Primary](#)
- [Time](#)
- [Universal Connect](#)
- [Video Memory](#)
- [Wakeup on LAN](#)



NOTE: Your use of the System Setup program depends on the power management scheme (APM or ACPI) used by your operating system. See [Power Management Compliance \(APM Versus ACPI\)](#) for more information.

AC

AC, an option under **Power Management**, allows you to set different time-outs for the following options when you operate your computer from AC power: **Display Time-out**, **Disk Time-out**, **Suspend Time-out**, **S2D Time-out**, **Smart CPU Mode**, **Display Close**, and **Brightness**.

A change to the AC option takes effect immediately (rebooting is not required).

Admin Password

Admin Password displays the current status of your administrator password and allows you to assign or change this password. Settings for this option are:

- **Disabled** (the default) — Indicates that no administrator password is assigned.
- **Enabled** — Indicates that an administrator password is currently assigned. All system setup functions, except passwords, are locked out.

The administrator password is designed for use by system administrators and service technicians in corporate environments. If an administrator password is assigned, you can use it to access the computer even if you do not know the primary password.

NOTICE: The password features provide a high level of security for the data in your computer. However, they are not foolproof. If your data requires more security, you should obtain and use additional forms of protection, such as data encryption programs or PC Cards with encryption features.

Alarm Resume

The **Alarm Resume** option directs the computer to resume normal operation when it is in suspend mode and detects an alarm from the real-time clock (RTC). Such alarms can be set through various application programs. In order for the alarms in these programs to work, the **Alarm Resume** option must be set to **Enabled**.



*NOTE: With systems running under ACPI, settings for power management features, such as suspend/sleep mode are controlled from the **Power Management Properties** window in the **Control Panel**.*

Settings for this option are:

- **Enabled** (the default) — Resumes normal operation when the computer detects an alarm.
- **Disabled** — Keeps the computer in suspend mode even if the computer detects an alarm.

A change to the **Alarm Resume** option takes effect immediately (rebooting is not required).

Asset Tag

The **Asset Tag** option displays the asset tag code if you or your organization assigned one to your computer.

For more information, see "[Asset Tag Utility](#)."

Audio Mode

Audio Mode manages the audio resources of the computer and the external devices you use with it. This mode is set to **Full Duplex**, which allows the computer's audio system to play and record sounds

simultaneously.

 *NOTE: The system does not allow you to select this mode for change.*

Battery

Battery, an option of **Power Management**, allows you to set different time-outs for the following options when you operate your computer from battery power: **Display Time-out**, **Disk Time-out**, **Suspend Time-out**, **S2D Time-out**, **Smart CPU Mode**, **Display Close**, and **Brightness**.

A change to the **Battery** option takes effect immediately (rebooting is not required).

Battery Status

Battery Status (page 3 of the System Setup screens) is a graphical representation of the approximate amount of charge left in the main and secondary batteries. No user-selectable settings are available for this option. If a battery is not installed in the main battery compartment or in the modular bay, the battery gauge illustration indicates **Battery Status: Not Installed**.

If you are not in the System Setup program, you can see the battery gauge illustration at any time by pressing <Fn><F3>.

 *NOTE: Certain key combinations may not function with the Advanced Configuration and Power Interface (ACPI) or may require activation with the **Power Management Properties** window in the **Control Panel**.*

BIOS Version

BIOS Version displays the version number and release date of the BIOS in your computer. A service technician may ask you for this version number if you call Dell for technical assistance.

 *NOTE: Dell may periodically offer revisions of the BIOS that add features or solve specific problems. Because the BIOS for your computer is stored on a reprogrammable flash-memory chip, you can use the **Flash BIOS Update** program to update your computer's BIOS entirely through software.*

Boot First Device

Boot First device determines which disk device your computer uses to find the software needed to start the operating system.

The term *boot* refers to the computer's start-up procedure. When you turn on the computer, it "bootstraps" itself into an operational state by loading into memory a small program, which in turn loads the necessary operating system. **Boot First device** tells the computer where to look first for the files that it needs to load.

Settings for this option are:

- **Diskette Drive** (the default) — Causes your computer to attempt first to boot from a bootable diskette loaded in a diskette drive in the system modular bay. This option will also cause your computer to attempt first boot from the media in an LS-120 drive if there is no diskette drive attached to the system and the LS-120 drive is installed in the system modular bay.
- **Internal HDD** — Causes your computer to boot from the hard-disk drive
- **CD/DVD/CD-RW Drive** — Causes your computer to attempt first to boot from a bootable CD, DVD, or CD-RW when that drive is installed in the system modular bay.
- **Modular Bay HDD** — Causes your computer to attempt first to boot from the second hard-disk drive installed in the modular bay
- **None** — Causes your computer to skip the boot option
- **PCI Slot NIC** — Causes your computer to attempt first to boot from a network source connected to the NIC card installed in the C/Dock or C/Dock II Station (if the feature is supported by the NIC card)
- **Dock II/Port II NIC** — Causes your computer to attempt first to boot from a network source connected to the C/Dock II Station or C/Port II Dock via the embedded NIC card.
- **CardBus NIC** — Causes your computer to attempt first to boot from a network source connected to the PCMCIA card NIC (if this capability is supported by the PCMCIA card).

For a change in the **Boot First device** option to take effect, you must reboot your computer.

Boot Second Device

If the computer cannot find the software it needs to start the operating system on the drive identified in **Boot First device**, it will search the device named in **Boot Second device**.

Settings for the option are:

- **Internal HDD** (the default) — Causes your computer to attempt to boot from the hard-disk drive
- **Diskette Drive** — Causes your computer to attempt first to boot from a bootable diskette loaded in a diskette drive in the system modular bay. This option will also cause your computer to attempt first boot from the media in an LS-120 drive if there is no diskette drive attached to the system and the LS-120 drive is installed in the system modular bay.
- **CD/DVD/CD-RW Drive** — Causes your computer to attempt first to boot from a bootable CD, DVD, or CD-RW when that drive is installed in the system modular bay.
- **Modular Bay HDD** — Causes your computer to boot from the second hard-disk drive installed in the modular bay
- **None** — Causes your computer to skip the boot option
- **PCI Slot NIC** — Causes your computer to attempt first to boot from a network source connected to the NIC card installed in the C/Dock or C/Dock II Station (if the feature is supported by the NIC card)

- **Dock II/Port II NIC** — Causes your computer to attempt first to boot from a network source connected to the C/Dock II Station or C/Port II Dock via the embedded NIC card
- **CardBus NIC** — Causes your computer to attempt first to boot from a network source connected to the PCMCIA card NIC (if this capability is supported by the PCMCIA card).

For a change in the **Boot Second device** option to take effect, you must reboot your computer.

Boot Third Device

If the computer cannot find the software it needs to start the operating system on the drive identified in **Boot First Device** or **Boot Second device**, it will search the device named in **Boot Third device**.

Settings for the option are:

- **None** (the default)
- **Internal HDD** — Causes your computer to attempt to boot from the hard-disk drive
- **Diskette Drive** — Causes your computer to attempt first to boot from a bootable diskette loaded in a diskette drive in the system modular bay. This option will also cause your computer to attempt first boot from the media in an LS-120 drive if there is no diskette drive attached to the system and the LS-120 drive is installed in the system modular bay.
- **CD/DVD/CD-RW Drive** — Causes your computer to attempt first to boot from a bootable CD, DVD, or CD-RW when that drive is installed in the system modular bay.
- **Modular Bay HDD** — Causes your computer to attempt to boot from the second hard-disk drive installed in the modular bay
- **PCI Slot NIC** — Causes your computer to attempt first to boot from a network source connected to the NIC card installed in the C/Dock or C/Dock II Station (if the feature is supported by the NIC card)
- **Dock II/Port II NIC** — Causes your computer to attempt first to boot from a network source connected to the C/Dock II Station or C/Port II Dock via the embedded NIC card
- **CardBus NIC** — Causes your computer to attempt first to boot from a network source connected to the PCMCIA card NIC (if this capability is supported by the PCMCIA card).

For a change in the **Boot Third device** option to take effect, you must reboot your computer.

Boot Speed

Boot Speed allows you to choose between the computer's processing speed (the default) and **Compatible**, a slower compatibility speed. The compatibility speed varies, depending on the configuration of your system.

When you change the setting in the **Boot Speed** option, the System Setup program stores and continues to display the new setting even if you do not reboot your computer when you exit the System Setup program. If

you start the System Setup program again during your current work session, the processing speed displayed for the **Boot Speed** option may not match the actual speed at which your computer is running.

For a change in the **Boot Speed** option to take effect, you must reboot your computer.

Brightness

Brightness allows you to specify the brightness of the display when the computer is operating on battery power. Use the left- and right-arrow keys to change the brightness of the display. When the computer is powered by a battery, the default is **Minimum**. If the computer is using AC power, the default is **Maximum**.

A change to the **Brightness** option takes effect immediately (rebooting is not required).

Click Volume

Click Volume allows you to disable or adjust the volume of the keyboard clicks if the **Keyboard Click** option is enabled. The default is **Maximum**.

A change to the **Click Volume** option takes effect immediately (rebooting is not required).



NOTE: This option also controls the volume of the PC Card and error message beep codes.

Configure Setup

Configure Setup allows you to restrict access to the System Setup program in the same way a system password restricts access to the system. Only available when you set the administrator password.

CPU Serial Number

CPU Serial Number enables support of the Intel® Mobile Pentium® III processor serial number. This field allows you to enable or disable recognition of the serial number of an Intel Mobile Pentium III processor.

Settings for this option are:

- **Disabled** (the default) — Indicates that the serial number cannot be read.
 - **Enabled** — Indicates that the serial number can be read.
-

Date

Date resets the date on the computer's internal calendar.

Your computer automatically displays the day of the week corresponding to the settings in the three fields that follow (**month**, **day-of-the-month**, and **year**).

A change to the **Date** option takes effect immediately (rebooting is not required). However, you must reboot

to make the change apparent to the operating system.

To change the date, press the right-arrow key to increase the number in the highlighted field, or press the left-arrow key to decrease the number. If you prefer, you can type in numbers in the **month** and **day-of-the-month** fields.

Disk Time-out

Disk Time-out lets you determine how long your hard-disk drive remains idle before the drive motor turns off to conserve battery power.

 *NOTE: This feature does not function with the Advanced Configuration and Power Interface (ACPI).*

The **AC** option is set to **Disabled**. No user-selectable settings are available for this option. Settings for **Battery** option are:

- Disabled
- 5 Minutes
- 15 Seconds
- 10 Minutes
- 1 Minute
- 15 Minutes
- 2 Minutes
- 30 Minutes
- 3 Minutes
- 1 Hour
- 4 Minutes

The default is **3 Minutes** if the computer is powered by a battery. To increase battery operating time, set **Disk Time-out** to a lower number. However, if your software requires frequent hard-disk drive accesses, using a higher time-out setting may save battery power and time by minimizing the number of times the hard-disk drive must power up.

 *NOTE: Set **Disk Time-out** to **Disabled** if using it causes compatibility problems with your software.*

A change to the **Disk Time-out** option takes effect immediately (rebooting is not required).

If you are not in the System Setup program, you can turn off the hard-disk drive immediately by pressing <Fn><h>. The drive resumes normal operation automatically when it is accessed by the microprocessor.

 *NOTE: Certain key combinations may not function with the Advanced Configuration and Power Interface (ACPI) or may require configuration with the **Power Management Properties** window in the **Control Panel**. See [Power Management Settings](#).*

Diskette Drive A

Diskette Drive A identifies the location of the 3.5-inch diskette drive: **Modular Bay**, **Parallel Port**, or **Not Installed**. No user-selectable settings are available for this option.

Diskette Drive B

Diskette Drive B identifies the location of a second 3.5-inch diskette drive: **Parallel Port**, **Modular Bay**, or **Not Installed**. No user-selectable settings are available for this option.

Diskette Reconfig

Diskette Reconfig allows application programs that access the diskette drive to run at their optimum speed. Settings are **At Reboot Only** and **Any Time**.

When **Diskette Reconfig** is set to **Any Time** (the default), you do not have to reboot after you install a diskette drive in the modular bay or attach a diskette drive to the parallel connector on the back of the computer. However, some application programs such as virus scans that access the diskette drive will run very slowly if the diskette drive is not in the modular bay or connected to the parallel port. When **Diskette Reconfig** is set to **At Reboot Only**, such application programs run at normal speed, but you must reboot after installing or attaching a diskette drive.

Display Close

Display Close lets you determine whether your computer enters suspend mode when the display is closed or whether only the display is turned off.

- **Suspend** (the default) — Allows the computer to enter suspend mode when the display is closed.
- **Active** — Turns off the display, but does not put the computer into suspend mode.



*NOTE: With systems running under ACPI, settings for these features are controlled from the **Power Management Properties** window in the **Control Panel**. Under ACPI, suspend mode is referred to as sleep mode. Activate the sleep mode by selecting **Sleep** from the **Power Management Properties** window.*

Display Time-out

Display Time-out lets you decide how long the computer operates with no input/output (I/O) activity before turning off the display to conserve battery power.

Settings for this option in both the **AC** and **Battery** categories are:

- Disabled
- 1 Minute
- 5 Minutes
- 10 Minutes

2 Minutes 15 Minutes

• 3 Minutes • 30 Minutes

• 4 Minutes • 1 Hour

The **Battery** default is **4 Minutes**. To increase battery operating time, set **Display Time-out** to a lower number of minutes.



*NOTE: Set the **Display Time-out** option to **Disabled** if using it causes compatibility problems with your software.*

A change to the **Display Time-out** option takes effect immediately (rebooting is not required).

If you are not in the System Setup program, you can turn off the display immediately by pressing <Fn><d>. The display resumes normal operation automatically when you press a key or move the cursor.



*NOTE: With systems running under ACPI, settings for this feature are controlled from the **Power Management Properties** window in the **Control Panel**. Key combinations for power management activities must be configured in the **Power Management Properties** window.*

Docking Ethernet

Docking Ethernet enables or disables the internal ethernet controller in the a Dell Latitude C/Port Family Advanced Port Replicator (C/Port APR) or C/Dock Family Expansion Station. A change to this option takes effect when you reboot.

Docking IRQ

Docking IRQ tells the computer which IRQ to assign to the docking station or replicator during the boot sequence. If this option is set to Optimized, the docking station or replicator is assigned a dedicated IRQ during the boot sequence. Select IRQ 11 if a peripheral device requires the use of the dedicated IRQ.

Docking Status

Docking Status shows whether the computer is attached to a Dell Latitude C/Port Family APR or C/Dock Family Expansion Station. No user-selectable settings are available for this option.

External Hot Key

External Hot Key lets you use the <Scroll Lock> key on the external keyboard the same way you use the <Fn> key on the computer's built-in keyboard. Set this option to **Scroll Lock** (the default) if you are using an external keyboard. Set this option to **Not Installed** to disable this function on the external keyboard.

Hard-disk Drive Password(s)

- **System Primary Password**
- **System Modular Bay Password**
- **Dock Media Bay Password**

Hard-disk drive password(s) displays the current status of the primary hard-disk drive password and allows you to assign or change this password. You can set a primary password for the system, the system modular bay, and the dock media bay.

Settings for this option are:

- **Disabled** (the default) — Indicates that no password is assigned
- **Enabled** — Indicates that a password is currently assigned

NOTICE: The password features provide a high level of security for the data in your computer. However, they are not foolproof. If your data requires more security, you should obtain and use additional forms of protection, such as data encryption programs or PC Cards with encryption features.

Infrared Data Port

Infrared Data Port allows you to avoid resource conflicts by remapping the address of the infrared ports or disabling the port. The **COM1**, **COM2**, **COM3**, and **COM4** settings allow you to take advantage of the computer's Fast IR support.



*NOTE: Before you enable infrared driver support, you must enable the **Infrared Data Port** option by selecting a COM setting (**COM3** is recommended). You must also set the **Infrared Mode** option to either **Fast IR** or **Slow IR**.*

Settings for this option are:

- **Disabled** (the default) — Disables the infrared data port and makes the direct memory access (DMA), interrupt request (IRQ), and I/O resources available for another serial device to use
- **COM1** — Maps the infrared data port to COM1
- **COM2** — Maps the infrared data port to COM2
- **COM3** — Maps the infrared data port to COM3
- **COM4** — Maps the infrared data port to COM4

For a change in the **Infrared Data Port** option to take effect, you must reboot your computer.

Infrared Mode

Infrared Mode sets the data transfer rates of the infrared transmitter in the system or the dock.



*NOTE: Before you enable infrared support, you must enable the **Infrared Data Port** option by selecting a COM setting (**COM3** is recommended). You must also set the **Infrared Mode** option to either **Fast IR** or **Slow IR**.*

Keyboard Click

Keyboard Click lets you choose whether the built-in keyboard makes audible clicking sounds. The **Click Volume** option must be enabled for this option to function. The volume of the simulated key clicks is controlled by the setting in the **Click Volume** option.

Settings for this option are **Disabled** (the default) and **Enabled**.

A change to the **Keyboard Click** option takes effect immediately (rebooting is not required).

Level 2 Cache

Level 2 Cache tells you how much cache memory your computer has. No user-selectable settings are available for this option.

Modular Bay

Modular Bay identifies the kind of device—**Diskette Drive**, **Battery**, **HDD** (hard-disk drive—indicates the drive's size), **LS-120**, **DVD-ROM**, **CD-ROM**, or **CD-RW Drive**—that is installed in the modular bay. If the modular bay does not contain a device or if a travel bay is installed, this option reads **Not Installed**. No user-selectable settings are available for this option.

Microprocessor

Microprocessor displays the type and speed of the microprocessor installed on your computer's system board. No user-selectable settings are available for this option.

Num Lock

Num Lock determines if the system boots with the Num Lock enabled or disabled when an external keyboard is attached.

Settings for this options are

- **Disabled** (the default)
- **Enabled**.

A change to the **Num Lock** option has no effect when the system is booted unless an external keyboard is attached.

Parallel Mode

Parallel Mode controls whether the computer's integrated parallel port acts as a Personal System/2 (PS/2)-compatible (**Bidirectional**) port, Advanced Technology (AT)-compatible (**Normal**) port, or Extended Capabilities Port (**ECP**)-compatible port. The default for **Parallel Mode** is **ECP**.

Windows 95 and 98 use ECP protocol automatically if it detects an ECP-compatible device.

Set this option according to the type of peripheral device connected to the parallel port. To determine the correct mode to use, see the documentation that came with the device.



*NOTE: The **ECP** setting also works for most software written for the AT and PS/2 modes. Devices that use **ECP** mode may come with special drivers that need to be installed in order to use these modes.*

Setting **Parallel Mode** to **Disabled** disables the parallel port and its assigned LPT address, freeing its interrupt for another device to use.

For a change in the **Parallel Mode** option to take effect, you must reboot your computer.

Pointing Device

Pointing Device enables and disables the computer's touch pad and track stick.

Settings for this option are:

- **Touch Pad-PS/2 Mouse** (the default)
- **Serial Mouse** — Disables the touch pad and track stick and allows you to use a mouse connected to the serial connector on the I/O port
- **PS/2 Mouse** — Disables the integrated touch pad when a PS/2 mouse is present.

If you want to use a serial mouse, you must first set the **Pointing Device** option to **Serial Mouse**.

For a change in the **Pointing Device** option to take effect, you must reboot your computer.

Power Management

Power Management allows you to enable or disable power conservation features when the computer is being powered by a battery or AC power. When this option is disabled, the related power management functions are not visible.

If you want to use any of the time-out options while using battery power, set the **Battery** option to **Enabled**. If you want to use the time-out options while using AC power, the set the **AC** option to **Enabled**.



NOTE: With systems running under ACPI, power management settings are controlled from the **Power Management Properties** window in the **Control Panel**.

A change to the **Power Management** option takes effect immediately (rebooting is not required).

Primary Hard Drive

Primary Hard Drive displays the capacity of your computer's hard-disk drive. No user-selectable settings are available for this option.

Primary Password

Primary Password displays the current status of the primary password and allows you to assign or change this password.

Settings for this option are:

- **Disabled** (the default) — Indicates that no primary password is assigned
- **Enabled** — Indicates that a primary password is currently assigned

If you assign a primary password, the computer prompts you for the password each time you boot the computer.

NOTICE: The password features provide a high level of security for the data in your computer. However, they are not foolproof. If your data requires more security, you should obtain and use additional forms of protection, such as data encryption programs or PC Cards with encryption features.

Ring/Event Resume

Ring/Event Resume lets you determine if the computer exits suspend mode when an installed modem card receives an incoming call. This feature is supported if the optional internal modem is installed; to use this feature with a modem PC card, it must be supported by the PC Card and by your operating system.



NOTE: With systems running under ACPI, power management settings are controlled from the **Power Management Properties** window in the **Control Panel**. Certain features require configuration through the **Power Management Properties** window and others may not function with ACPI.

Settings for this option are:

- **Enabled** (the default) — Resumes normal operation when the computer detects a modem ring
- **Disabled** — Keeps the computer in suspend mode when the computer detects a modem ring



NOTES: Dell recommends that you set **Ring/Event Resume** to **Disabled** when an external serial device, **other than a modem**, is connected to your computer.

In order for the **Ring/Event Resume** option to work properly, this feature must be enabled in the device driver for your modem PC Card. All drivers supplied by Dell with your computer are configured to allow the computer to resume normal operation when a modem receives an incoming call. If you use a PC Card that you did not receive from Dell, check the documentation to make sure this feature is set to **Enabled**.

A change to the **Ring/Event Resume** option takes effect immediately (rebooting is not required).

S2D Time-out

S2D Time-out lets you determine how long your computer remains idle (no I/O activity) before activating suspend-to-disk (S2D) mode to conserve battery power.



*NOTE: With systems running under ACPI, settings for power management features, such as key combinations and suspend-to-disk mode, are controlled from the **Power Management Properties** window in the **Control Panel**. The key combinations of <Fn><a> or <Scroll Lock><a> may not function with ACPI if the settings have not been activated from the **Power Management Properties** window.*

*The suspend-to-disk mode is referred to as the hibernate mode for systems running ACPI. To activate the hibernate mode, make sure that you have configured the appropriate key combinations from the **Power Management Properties** window.*

Settings for this option in both the **AC** and **Battery** categories are:

- Disabled
- 30 Minutes
- 1 Hour
- 2 Hours
- 3 Hours
- 4 Hours
- 6 Hours
- 8 Hours (default)
- 12 Hours

A change to the **S2D Time-out** option takes effect immediately (rebooting is not required).

If you are not in the System Setup program, you can activate **S2D Time-out** mode at any time by pressing <Fn><a>. Press the power switch to resume from S2D mode.

Serial Port

Serial Port allows you to map the address of the serial port or to disable the serial port.

Settings for this option are:

COM1 (the default) — Maps the serial port to COM1

- **COM2** — Maps the serial port to COM2
- **COM3** — Maps the serial port to COM3
- **COM4** — Maps the serial port to COM4
- **Disabled** — Disables the serial port and its assigned COM address, freeing that interrupt for another device to use

For a change in the **Serial Port** option to take effect, you must reboot your computer.

Service Tag

Service Tag displays the computer's service code, which was programmed into NVRAM by Dell during the manufacturing process. Be prepared to supply this identification during technical assistance or service calls. The service tag is also accessed by certain Dell support software, including diagnostics. No user-selectable settings are available for this option.



*NOTE: Convert the service tag number into an express service code when prompted to do so the first time you turn on the computer (or use the program in the **Dell Accessories** folder). Keep the code handy in case you call Dell for technical assistance. The code helps Dell's automated support telephone system direct your call more efficiently.*

Smart CPU Mode

Smart CPU Mode allows the computer to slow down the microprocessor automatically if it is not being actively used. This feature is a key component to the thermal control of the system.



*NOTE: With systems running under ACPI, power management settings are controlled from the **Power Management Properties** window in the **Control Panel**. Certain features require configuration through the **Power Management Properties** window and others may not function with ACPI.*

Settings for this option are:

- **Enabled** (the default) — Saves power, helps to lower system temperatures, and extends battery life by allowing the computer to slow down the microprocessor when it is inactive
- **Disabled** — Keeps the microprocessor running at its normal operating speed regardless of microprocessor inactivity (can reduce battery life)



*NOTES: In rare situations, some communications software may not work properly when **Smart CPU Mode** is enabled. Dell recommends that you set **Smart CPU Mode** to **Disabled** if your computer is experiencing performance degradation.*

*Interactive application programs should function well when **Smart CPU Mode** is set to **Enabled**. (Examples of interactive programs include spreadsheet, text editor, graphics design, entertainment,*

educational, and utility programs.) However, you may experience performance degradation when recalculating a large spreadsheet or during an extensive screen redraw in a graphical program. Benchmark utilities may not perform as intended when doing microprocessor speed tests. If the software you use suffers significant performance degradation, set **Smart CPU Mode** to **Disabled**.

A change to the **Smart CPU Mode** option takes effect immediately (rebooting is not required).

Intel SpeedStep™ Setup

SpeedStep Setup allows you to set the performance level for the microprocessor to maximum performance or minimum performance on battery or AC power.

 **NOTES:** This utility is available only for CPx J-Series systems.

With systems running under ACPI, power management settings are controlled from the **Power Management Properties** window in the **Control Panel**. Certain features require configuration through the **Power Management Properties** window and others may not function with ACPI.

Settings for this option are:

- **Disabled** (the default) — Sets the system to operate in the lowest performance mode possible. When this option is selected, the SpeedStep tab of the Power Management Properties window will not be available.
 - **Automatic** — Allows the BIOS to set the system into either AC performance or Battery performance mode at POST, based on AC availability.
 - **Maximum Optimized AC** — Allows the BIOS to set the microprocessor to highest performance mode possible, if the AC adapter is inserted.
 - **Battery Optimized** — Allows the BIOS to set the microprocessor to the lowest performance mode possible, if the AC adapter is inserted.
-

Suspend Time-out

Suspend Time-out lets you determine how long your computer remains idle before activating suspend mode to conserve battery power.

 **NOTE:** With systems running under ACPI, power management settings are controlled from the **Power Management Properties** window in the **Control Panel**. Certain features require configuration through the **Power Management Properties** window and others may not function with ACPI.

Settings for this option in both **AC** and **Battery** categories are:

- Disabled
- 5 Minutes
- 1 Minute
- 10 Minutes (default)
- 2 Minutes
- 15 Minutes

- 3 Minutes
- 30 Minutes
- 4 Minutes
- 1 Hour

To increase battery operating time, set the **Suspend Time-out** option to a lower number of minutes.



NOTE: Set the **Suspend Time-out** option to **Disabled** if using it causes compatibility problems with your software.

A change to the **Suspend Time-out** option takes effect immediately (rebooting is not required).

If you are not in the System Setup program, you can activate suspend mode at any time by pressing <Fn><Esc>. The computer resumes normal operation automatically when you press the power button.

System Memory

System Memory displays the total amount of synchronous dynamic random-access memory (SDRAM) installed in your computer. No user-selectable settings are available for this option. The amount of memory displayed changes if you install or remove a memory module.

System Primary

System Primary displays the current status of the primary hard-disk drive password and allows you to assign or change this password.

Settings for this option are:

- **Disabled** (the default) — Indicates that no primary hard-disk drive password is assigned
- **Enabled** — Indicates that a primary hard-disk drive password is currently assigned

NOTICE: The password features provide a high level of security for the data in your computer. However, they are not foolproof. If your data requires more security, you should obtain and use additional forms of protection, such as data encryption programs or PC Cards with encryption features.

Time

Time resets the time on the computer's internal clock. Time is kept in a 24-hour format (hours:minutes:seconds).



NOTE: If a network server controls the time reflected by the **Time** option, changing this option has no effect.

A change to the **Time** option takes effect immediately (rebooting is not required). However, you must reboot

to make the change apparent to the operating system.

Universal Connect

The **Universal Connect** option functions with the Dell Latitude C/Port Family APR if the computer uses Windows 95 or Windows 98.

Set this option to **Enabled** (the default) if you often use more than one C/Port APR and want to minimize the initialization time when you connect the replicator to the computer. When this option is set to **Disabled**, the operating system generates a new profile each time you connect to a different docking device.

Video Memory

Video Memory displays the amount of video memory installed on the system board. No user-selectable settings are available for this option.

Wakeup on LAN

Wakeup on LAN enables the computer to power up when triggered by a special LAN signal.

A change to the **Wakeup on LAN** option takes effect immediately.

[Back to Contents Page](#)

Suspend-to-Disk Utility (For Windows 95, Windows 98, and Windows NT Only):

Dell™ Latitude™ CPx H-Series/J-Series User's Guide

 [Suspend-to-Disk Utility](#)

 [Removing the S2D Partition](#)

 [Creating the S2D Partition](#)

Suspend-to-Disk Utility

The Suspend-to-Disk (S2D) utility allows you to manage the S2D partition in your file system as your computing needs change. For instance, you can remove the S2D partition if you need the space on the hard-disk drive for other purposes, or you can use the S2D utility to create the partition if you have removed it.

Removing the S2D Partition

If you want to use the S2D partition on your hard-disk drive for another purpose (for instance, if you are running out of file space), perform the following steps to remove the partition:

1. At an MS-DOS® prompt, type `cd c:\dell\util` and press <Enter> to change to the directory on your hard-disk drive that contains the S2D utility files.

If you are using an operating system that is not compatible with MS-DOS, see the **readme.s2d** file for instructions.

2. Type `rms2d` and press <Enter>.

Status messages appear on the display as the removal process progresses. When the S2D partition has been removed, the following message appears:

The S2D partition was successfully removed.



NOTE: After you remove the S2D partition, the computer cannot activate suspend-to-disk mode until you recreate the partition. If you try to activate suspend-to-disk mode and receive the message `No Suspend-To-Disk partition available`, you must create an S2D partition.

Creating the S2D Partition

The **mks2d.exe** file creates the S2D partition the computer uses to store the system data that is saved when you put the computer in suspend-to-disk mode. Use the **mks2d.exe** file to create a new S2D partition in the following cases:

- If Dell did not install MS-DOS on your hard-disk drive
- If you increase the amount of system memory by adding a memory module
- If you used the **rms2d.exe** file to remove the original S2D partition and now want to recreate the partition
- If your hard-disk drive becomes corrupted
- If you install a new hard-disk drive
- If you received the system utilities separately on diskette or CD or if you deleted the S2D utility from your hard-disk drive

To create an S2D partition, perform the following steps.



*NOTE: If you are creating the partition on a new hard-disk drive, if Dell did not install MS-DOS on your hard-disk drive, or if you are using an operating system that is not compatible with MS-DOS, read the **readme.s2d** file before performing the following procedure.*

1. At an MS-DOS prompt, type `cd c:\dell\util` and press <Enter> to change to the directory on your hard-disk drive that contains the S2D utility files.
2. Type `mks2d` and press <Enter>.

As the utility builds the partition, status messages appear on the display. If an error message appears, it provides information about which steps to take to continue building the partition.

When the S2D partition has been built and verified, the following message appears:

```
The S2D partition was successfully created.
```

[Back to Contents Page](#)

Error Messages and Flash Codes: Dell™ Latitude™ CPx H-Series/J-Series User's Guide

[Error Messages](#)

[Memory Allocations](#)

[System Flash Codes](#)

[I/O Memory Map](#)

[Avoiding Interrupt Assignment Conflicts](#)

Error Messages

Your application programs, operating system, and the computer itself can identify problems and alert you to them. When this occurs, a message may appear on the computer's display or on an external monitor (if one is attached), or a flash code may be emitted.

If an error message appears on the display or external monitor, make a note of the message. For an explanation of the message and suggestions for correcting any errors, see [Table 1](#). The messages are listed alphabetically.

 **NOTE:** If the message is not listed in [Table 1](#), see the documentation for the application program that was running at the time the message appeared and/or the operating system documentation for an explanation of the message and a recommended action.

Table 1. System Error Messages

| Message | Cause | Action |
|---------------------------------|---|--|
| Auxiliary device failure | The touch pad, track stick, or external PS/2 mouse may be faulty. | If you are using an external mouse only, check the connection for a loose or improperly connected cable. If the problem persists, enable the Pointing Device option. If the problem persists, call Dell for technical assistance. |
| Bad command or file name | The command you entered does not exist or is not in the pathname you specified. | Make sure that you have typed the command correctly, placed spaces in the proper location, and used the correct pathname. |
| Cache disabled due to failure | The primary cache internal to the microprocessor has failed. | Call Dell for technical assistance. |
| Data error | The diskette or hard-disk drive cannot read the data. | Run the appropriate utility to check the file structure of the diskette drive or hard-disk drive. See the documentation that came with your operating system. |
| Decreasing available memory | One or more memory modules may be faulty or improperly seated. | Reseat the memory modules and, if necessary, replace them. |
| Disk C: failed initialization | The hard-disk drive failed initialization. | Run the Hard-Disk Drive tests in the Dell Diagnostics . |
| Diskette drive 0 seek failure | A cable may be loose, or the system configuration information may not match the hardware configuration. | Run the Diskette Drive tests in the Dell Diagnostics . If error is not corrected, have the cables checked by an authorized service technician. |
| Diskette read failure | A cable may be loose, or the diskette may be faulty. | If the diskette-drive access indicator lights up, try a different diskette. |
| Diskette subsystem reset failed | The diskette drive controller may be faulty. | Run the Diskette Drive tests in the Dell Diagnostics . |
| Diskette write- | Because the diskette is write-protected, | Slide the write-protect notch up. |

| | | |
|---|---|--|
| protected | the operation cannot be completed. | |
| Drive not ready | No diskette is in the diskette drive, or no hard-disk drive is in the drive bay. The operation requires a diskette in the drive or a hard-disk drive in the bay before it can continue. | Put a diskette in the drive, or push the diskette all the way into the drive until the eject button pops out. Or, install a hard-disk drive in the drive bay. |
| Error reading PCMCIA card | The computer cannot identify the PC Card. | Reseat the card or try another PC Card that you know works. |
| Extended memory size has changed | The amount of memory recorded in NVRAM does not match the memory installed in the computer. | Reboot the computer. If the error appears on the display again, call Dell for technical assistance. |
| Gate A20 failure | An installed memory module may be loose. | Reseat the memory modules and, if necessary, replace them. |
| General failure | The operating system is unable to carry out the command. | This message is usually followed by specific information—for example, <code>Printer out of paper</code> . Respond by taking the appropriate action. |
| Hard-disk drive configuration error | The computer cannot identify the drive type. | Turn off the computer, remove the drive, and boot the computer from a bootable diskette. Then turn off the computer, reinstall the drive, and reboot the computer. Run the Hard-Disk Drive tests in the Dell Diagnostics . |
| Hard-disk drive controller failure 0 | The hard-disk drive does not respond to commands from the computer. | Turn off the computer, remove the drive, and boot the computer from a bootable diskette. Then turn off the computer again, reinstall the drive, and reboot the computer. If the problem persists, try another drive. Then run the Hard-Disk Drive tests in the Dell Diagnostics . |
| CD-ROM drive controller failure 1 | The CD-ROM drive does not respond to commands from the computer. | Turn off the computer, remove the drive, and boot the computer from a bootable diskette. Then turn off the computer again, reinstall the drive, and reboot the computer. If the problem persists, try another drive. Then run the CD-ROM Drive tests in the Dell Diagnostics . |
| Hard-disk drive failure | The hard-disk drive does not respond to commands from the computer. | Turn off the computer, remove the drive, and boot the computer from a bootable diskette. Then turn off the computer again, reinstall the drive, and reboot the computer. If the problem persists, try another drive. Then run the Hard-Disk Drive tests in the Dell Diagnostics . |
| Hard-disk drive read failure | The hard-disk drive may be faulty. | Turn off the computer, remove the drive, and boot the computer from a bootable diskette. Then turn off the computer again, reinstall the drive, and reboot the computer. If the problem persists, try another drive. Then run the Hard-Disk Drive tests in the Dell Diagnostics . |
| Invalid configuration information—please run System Setup Program | The system configuration information does not match the hardware configuration. This message is most likely to occur after a memory module is installed. | Correct the appropriate options in the System Setup program. |
| Keyboard clock line failure | A cable or connector may be loose, or the keyboard may be faulty. | Run the Keyboard Controller test in the Dell Diagnostics . |
| Keyboard controller failure | A cable or connector may be loose, or the keyboard may be faulty. | Reboot the computer, and avoid touching the keyboard or the mouse during the boot routine. If the problem persists, run the Keyboard Controller test in the Dell Diagnostics . |
| Keyboard data line failure | A cable or connector may be loose, or the | Run the Keyboard Controller test in the Dell Diagnostics . |

| | | |
|---|--|--|
| | keyboard may be faulty. | |
| Keyboard stuck key failure | If an external keyboard or keypad is being used, a cable or connector may be loose or the keyboard may be faulty. If the integrated keyboard is being used, the keyboard may be faulty. A key on the integrated keyboard or external keyboard may have been pressed while the computer was booting. | Run the Stuck Key test in the Dell Diagnostics . |
| Memory address line failure at address, read value expecting value | An installed memory module may be faulty or improperly seated. | Reseat the memory modules and, if necessary, replace them. |
| Memory allocation error | The software you are attempting to run is conflicting with the operating system, another application program, or a utility. | Turn off the computer, wait 30 seconds, and then restart it. Try to run the program again. If the problem persists, contact the software company. |
| Memory data line failure at address, read value expecting value | An installed memory module may be faulty or improperly seated. | Reseat the memory modules and, if necessary, replace them. |
| Memory double word logic failure at address, read value expecting value | An installed memory module may be faulty or improperly seated. | Reseat the memory modules and, if necessary, replace them. |
| Memory odd/even logic failure at address, read value expecting value | An installed memory module may be faulty or improperly seated. | Reseat the memory modules and, if necessary, replace them. |
| Memory write/read failure at address, read value expecting value | An installed memory module may be faulty or improperly seated. | Reseat the memory modules and, if necessary, replace them. |
| No boot device available | The computer cannot find the diskette or hard-disk drive. | If the diskette drive is your boot device, make sure that there is a bootable diskette in the drive. If the hard-disk drive is your boot device, make sure that the drive is installed, properly seated, and partitioned as a boot device. |
| No boot sector on hard-disk drive | The operating system may be corrupted. | Reinstall your operating system. See the documentation that came with your operating system. |
| No timer tick interrupt | A chip on the system board may be malfunctioning. | Run the System Set tests in the Dell Diagnostics . |
| Non-system disk or disk error | The diskette in drive A or your hard-disk drive does not have a bootable operating system installed on it. | If you are trying to boot from the diskette, replace it with one that has a bootable operating system. |
| Not a boot diskette | There is no operating system on the diskette. | Boot the computer with a diskette that contains an operating system. |
| Optional ROM bad checksum | The optional ROM apparently failed. | Call Dell for technical assistance. |

| | | |
|---|---|--|
| Sector not found | The operating system cannot locate a sector on the diskette or hard-disk drive. You probably have a bad sector or corrupted FAT on the diskette or hard-disk drive. | Run the appropriate utility to check the file structure on the diskette or hard-disk drive. If a large number of sectors are defective, back up the data (if possible), and then reformat the diskette or hard-disk drive. |
| Seek error | The operating system cannot find a specific track on the diskette or hard-disk drive. | If the error is on the diskette drive, try another diskette in the drive. |
| Shutdown failure | A chip on the system board may be malfunctioning. | Run the System Set tests in the Dell Diagnostics . |
| Time-of-day clock lost power | Data stored in NVRAM has become corrupted. | Connect your computer to an electrical outlet to charge the battery. If the problem persists, try to restore the data. To restore the data, press <Fn><F1> to enter the System Setup program . Then immediately exit it. If the message reappears, call Dell for technical assistance. |
| Time-of-day clock stopped | The reserve battery that supports the data stored in NVRAM may be read. | Connect your computer to an electrical outlet to charge the battery. If the problem persists, call Dell for technical assistance. |
| Time-of-day not set-please run the System Setup program | The time or date stored in the System Setup program does not watch the system clock. | Correct the settings for the Date and Time options. (For instructions, see " System Setup Program .") |
| Timer chip counter 2 failed | A chip on the system board may be malfunctioning. | Run the System Set tests in the Dell Diagnostics . |
| Unexpected interrupt in protected mode | The keyboard controller may be malfunctioning, or an installed memory module may be loose. | Run the System Memory tests and the Keyboard Controller test in the Dell Diagnostics . |
| Warning: Battery is critically low. | The battery is running out of charge. | Replace the battery , or connect the computer to an electrical outlet. Otherwise, activate suspend-to-disk mode or turn off the computer. |

System Flash Codes

When errors that occur during the boot routine cannot be reported on the built-in display or on an external monitor (if attached), the Num Lock, Caps Lock, and Scroll Lock indicators (see [Figure 1](#)) may flash together in a pattern of lights (or *flash code*) that identifies the problem. For example, one flash, followed by a second flash, and then a burst of three flashes (code 1-1-3) means that the computer was unable to read the data in nonvolatile random-access memory (NVRAM). This information is important to the Dell support staff if you need to call for technical assistance.

The Num Lock, Caps Lock, and Scroll Lock indicators flash briefly when the computer is turned on. The flash codes, if needed, occur after the boot routine.

Figure 1. Flash Code Indicators

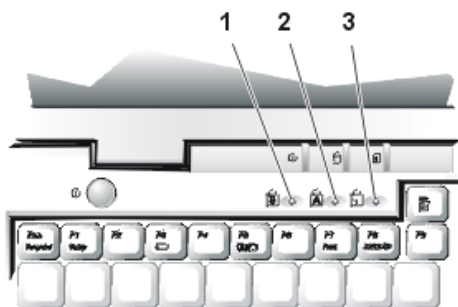

1 Scroll Lock

2 Caps Lock

3 Num Lock

When the computer emits a flash code, write it down on a copy of the [Diagnostics Checklist](#) and then look up its cause and meaning in [Table 2](#). If you are unable to resolve the problem, use the [Dell Diagnostics](#) to identify a more serious cause. If you are still unable to resolve the problem, [call Dell](#) for technical assistance.

Table 2. Flash Codes and Corrective Actions

| Message | Cause | Action |
|---------------------|--|---|
| 1-1-3 | NVRAM write/read failure. | Run the System Set tests in the Dell Diagnostics . If the program does not load, call Dell for technical assistance. |
| 1-1-4 | ROM BIOS checksum failure. | Run the System Set tests in the Dell Diagnostics . If the program does not load, call Dell for technical assistance. |
| 1-2-1 | Programmable interval timer failure. | Run the System Set tests in the Dell Diagnostics . If the program does not load, call Dell for technical assistance. |
| 1-2-2 | DMA initialization failure. | Run the System Set tests in the Dell Diagnostics . If the program does not load, call Dell for technical assistance. |
| 1-2-3 | DMA page register write/read failure. | Run the System Set tests in the Dell Diagnostics . If the program does not load, call Dell for technical assistance. |
| 1-3-1 through 2-4-4 | An installed memory module is not being properly identified or used. | Make sure that a memory module is installed in one of the memory module sockets on the system board. The computer will not function unless at least one memory module is installed. |
| 3-1-1 | Slave DMA register failure. | Run the System Set tests in the Dell Diagnostics . If the program does not load, call Dell for technical assistance. |
| 3-1-2 | Master DMA register failure. | Run the System Set tests in the Dell Diagnostics . If the program does not load, call Dell for technical assistance. |
| 3-1-3 | Master interrupt mask register failure. | Call Dell for technical assistance. |
| 3-1-4 | Slave interrupt mask register failure. | Call Dell for technical assistance. |
| 3-2-4 | Keyboard controller test failure. | Run the Keyboard Controller test in the Dell Diagnostics . |
| 3-3-4 | Display memory test failure. | Run the Video Memory test in the Dell Diagnostics . |
| 3-4-1 | Display initialization failure. | Run the Video tests in the Dell Diagnostics . |
| 3-4-2 | Display retrace test failure. | Run the Video tests in the Dell Diagnostics . |
| 4-2-1 | No timer tick. | Call Dell for technical assistance. |
| 4-2-2 | Shutdown failure. | Call Dell for technical assistance. |
| 4-2-3 | Gate A20 failure. | Call Dell for technical assistance. |
| 4-2-4 | Unexpected interrupt in protected mode. | Call Dell for technical assistance. |
| 4-3-1 | Memory failure above address 0FFFFh. | Run the System Memory tests in the Dell Diagnostics . |
| 4-3-3 | Timer chip counter 2 failure. | Call Dell for technical assistance. |
| 4-3-4 | Time-of-day clock stopped. | Call Dell for technical assistance. |

| | | |
|-------|----------------------|--|
| 4-4-1 | Serial port failure. | Run the Serial/Infrared Ports tests in the Dell Diagnostics . |
| 5-1-2 | No usable memory. | Run the System Memory tests in the Dell Diagnostics . |

Avoiding Interrupt Assignment Conflicts

Problems can arise if two devices attempt to use the same interrupt request (IRQ) line. To avoid this type of conflict, check the documentation for the default IRQ line setting for each installed device. Then consult [Table 3](#) to configure the device for one of the available IRQ lines.

 **NOTES:** Installed devices cannot share the same COM port address. The default address of your computer's serial port is COM1.

To view IRQ line assignments in the Microsoft® Windows® 95 and Windows 98 operating systems, click the **Start** button, point to **Settings**, and click **Control Panel**. Double-click the **System** icon. Select the **Device Manager** tab, and then double-click **Computer**.

Table 3. IRQ Line Assignments

| IRQ Line | Reserved/Available |
|----------|--|
| IRQ0 | Reserved; generated by the system timer |
| IRQ1 | Reserved; generated by the keyboard controller to signal that the keyboard output buffer is full |
| IRQ2 | Reserved; generated internally by the interrupt controller to enable IRQ8 through IRQ15 |
| IRQ3 | Available for use by a PC Card unless the integrated serial port or infrared port is configured for COM2 or COM4 |
| IRQ4 | Available for use by a PC Card unless the integrated serial port or infrared port is configured for COM1 (the default) or COM3 |
| IRQ5 | Available for use by the audio controller |
| IRQ6 | Generated by the diskette drive controller to indicate that the diskette drive requires the attention of the microprocessor |
| IRQ7 | Available for use by a PC Card or audio controller if the parallel port is disabled |
| IRQ8 | Reserved; generated by the system I/O controller's RTC |
| IRQ9 | Reserved; generated by the video controller |
| IRQ10 | Available for use by a PC Card or audio controller unless the C/Port Family APR or C/Dock Family Expansion Station is attached |
| IRQ11 | Generated by USB, PC Card, and audio controllers; available for use by a PC Card |
| IRQ12 | Reserved; generated by the keyboard controller to indicate that the output buffer of the DualPoint integrated pointing device or the external PS/2 mouse is full |
| IRQ13 | Reserved; generated by the math coprocessor |
| IRQ14 | Reserved; generated by the hard-disk drive to indicate that the drive requires the attention of the microprocessor |
| IRQ15 | Reserved; generated by CD-ROM drive in the modular bay to indicate that the drive requires the attention of the microprocessor |

Memory Allocations

[Table 4](#) provides a map of the conventional memory area. When the microprocessor or a program addresses a location within the conventional memory range, it is physically addressing a location in main memory.

 **NOTE:** To view memory allocations in Windows 95 and Windows 98, click the **Start** button, point to **Settings**, and click **Control Panel**. Double-click the **System** icon. Click the **Device Manager** tab, and then double-click **Computer**.

Table 4. Conventional Memory Map

| Address Range | Use |
|----------------|-----------------------------|
| 0000h-003FFh | Interrupt vector table |
| 00400h-00FFFFh | BIOS data area |
| 00500h-005FFh | MS-DOS® and BASIC work area |
| 00600h-9FBFFh | User memory |

[Table 5](#) provides a map of the upper memory area. Some of these addresses are dedicated to various system devices, such as the system/video basic input/output system (BIOS). Others are available for use by expansion cards and/or an expanded memory manager (EMM).

When the microprocessor or a program addresses a location within the upper memory area, it is physically addressing a location within one of these devices.

Table 5. Upper Memory Map

| Address Range | Use |
|-------------------|----------------------|
| 0009FC00-0009FFFF | PS/2-mouse data area |
| 000A0000-000BFFFF | Video RAM |
| 000C0000-000CFFFF | Video BIOS |
| 000CC000-000CDFFF | Reserved for PC Card |
| 000F0000-000FFFFF | System BIOS |
| 00100000-03FFFFFF | High memory area |
| FD000000-FDFFFFFF | Video RAM |
| FF200000-FF2FFFFF | Video RAM |
| FFFE0000-FFFFFF | BIOS ROM |

I/O Memory Map

[Table 6](#) provides a map of memory addresses reserved by the system for peripheral input/output (I/O) devices. Use the information in Table 6 to determine if the memory address of an external peripheral (such as a PC Card) conflicts with a memory address reserved by the system.

Check the documentation of the external I/O device to determine its memory address. If there is a conflict with a memory address reserved by the system, change the address of the device.

 **NOTE:** To view I/O addresses in Windows 95 and Windows 98, click the **Start** button, point to **Settings**, and click **Control Panel**. Double-click the **System** icon. Click the **Device Manager** tab, and then double-click **Computer**.

Table 6. I/O Memory Map

| Address | Device |
|-----------|-------------------------|
| 0000-001F | DMA controller #1 |
| 0020-003F | Interrupt controller #1 |
| 0040-005F | System timers |

| | |
|-----------|----------------------------|
| 0060-006F | Keyboard controller |
| 0070-007F | RTC and NMI enable |
| 0080-009F | DMA page registers |
| 00A0-00BF | Interrupt controller #2 |
| 00C0-00DF | DMA controller #2 |
| 00F0-00FF | Math coprocessor |
| 0170-0177 | CD-ROM drive controller |
| 01F0-01F7 | Hard-disk drive controller |
| 0210-0217 | Audio controller |
| 0220-022F | Audio controller |
| 0270-0277 | Fast IR |
| 0376-0376 | IDE controller |
| 0378-037F | LPT1 |
| 0388-038B | Audio controller |
| 038B-03BB | VGA |
| 03C0-03DF | VGA |
| 03E0-03E1 | PC Card controller |
| 03E8-03EF | Fast IR |
| 03F0-03F7 | Diskette controller |
| 03F8-03FF | COM1 |
| 0530-0537 | Audio controller |
| 0778-077B | ECP registers |
| ECE0-ECFF | USB controller |
| FFA0-FFAF | PCI-IDE bus registers |

[Back to Contents Page](#)

Help Overview: Dell™ Latitude™ CPl C-Series Portable Computers User's Guide

 [Technical Assistance](#)

 [Product Information](#)

 [Help Tools](#)

 [Returning Items for Warranty Repair or Credit](#)

 [Problems With Your Order](#)

 [Before You Call](#)

Technical Assistance

If you need assistance with a technical problem, perform the following steps:

1. Run the Dell Diagnostics.
2. Make a copy of the [Diagnostics Checklist](#) and fill it out.
3. Use Dell's extensive suite of online services available at Dell's World Wide Web site (<http://www.dell.com>) for help with installation and troubleshooting procedures.
4. If the preceding steps have not resolved the problem, call Dell for technical assistance.

When prompted by Dell's automated telephone system, enter your Express Service Code to route the call directly to the proper support personnel. If you do not have an Express Service Code, open the **Dell Accessories** folder, double-click the **Express Service Code** icon, and follow the directions.

 *NOTE: Dell's Express Service Code system may not be available in all countries.*

For instructions on using the technical support service, see "[Technical Support Service](#)" and "[Before You Call](#)."

Help Tools

Dell provides a number of tools to assist you. These tools are described in the following sections.

 *NOTE: Some of the following tools are not always available in all locations outside the continental U.S. Please call your local Dell representative for information on availability.*

World Wide Web

The Internet is your most powerful tool for obtaining information about your computer and other Dell products. Through the Internet, you can access most of the services described in this section, including AutoTech, TechFax, order status, technical support, and product information.

You can access Dell's support Web site at <http://support.dell.com>. Click the map that appears to select your country and the **Welcome to support.dell.com** page opens. Enter your system information to access help tools and information such as:

Support Your Dell — From this page you can access a number of tools and information such as system documentation, drivers and BIOS updates, and self-diagnostic tools for resolving many computer-related issues by following interactive flowcharts.

Ask Dudley — Enter a question about your computer or about software. This tool searches the Dell Knowledge Base and Dell Support for answers and related topics.

Communicate With Dell — Use Dell Talk Forum, a public discussion moderated by Dell technical support specialists, to obtain technical information or submit requests via e-mail to Dell Support.

You can contact Dell electronically by using the following addresses:

- World Wide Web

<http://www.dell.com/>

<http://www.dell.com/ap/> (for Asian/Pacific countries only)

<http://www.euro.dell.com> (for Europe only)

<http://www.dell.com/la/> (for Latin American countries)

- Anonymous file transfer protocol (FTP)

<ftp.dell.com/>

Log in as user: anonymous, and use your e-mail address as your password.

- Electronic Support Service

mobile_support@us.dell.com

apsupport@dell.com (for Asian/Pacific countries only)

support.euro.dell.com (for Europe only)

- Electronic Quote Service

sales@dell.com

apmarketing@dell.com (for Asian/Pacific countries only)

- Electronic Information Service

info@dell.com

AutoTech Service

Dell's automated technical support service—AutoTech—provides recorded answers to the questions most frequently asked by Dell customers.

When you call AutoTech, you use your touch-tone telephone to select the subjects that correspond to your questions. You can even interrupt an AutoTech session and continue the session later. The code number that the AutoTech service gives you allows you to continue your session where you ended it.

The AutoTech service is available 24 hours a day, seven days a week. You can also access this service through the technical support service. For the telephone number to call, see the [contact numbers](#) for your region.

TechFax Service

Dell takes full advantage of fax technology to serve you better. Twenty-four hours a day, seven days a week, you can call the Dell TechFax line toll-free for all kinds of technical information.

Using a touch-tone phone, you can select from a full directory of topics. The technical information you request is sent within minutes to the fax number you designate. For the TechFax telephone number to call, see the [contact numbers](#) for your region.

TechConnect BBS

Use your modem to access Dell's TechConnect bulletin board service (BBS) 24 hours a day, seven days a week. The service is menu-driven and fully interactive. The protocol parameters for the BBS are 1200 to 19.2K baud, 8 data bits, no parity, 1 stop bit.

Automated Order-Status System

You can call this automated service to check on the status of any Dell products that you have ordered. A recording prompts you for the information needed to locate and report on your order. For the telephone number to call, see the [contact numbers](#) for your region.

Technical Support Service

Dell's industry-leading hardware technical support service is available 24 hours a day, seven days a week, to answer your questions about Dell hardware.

Our technical support staff pride themselves on their track record: more than 90 percent of all problems and questions are taken care of in just one toll-free call, usually in less than 10 minutes. When you call, our experts can refer to records kept on your Dell system to better understand your particular question. Our technical support staff use computer-based diagnostics to provide fast, accurate answers to questions.

To contact Dell's technical support service, see "[Before You Call](#)" and then call the number for your country as listed in "[Contacting Dell](#)."

Problems With Your Order

If you have a problem with your order, such as missing parts, wrong parts, or incorrect billing, contact Dell for customer assistance. Have your invoice or packing slip handy when you call. For the telephone number to call, see the [contact numbers](#) for your region.

Product Information

If you need information about additional products available from Dell, or if you would like to place an order, visit Dell's World Wide Web site at <http://www.dell.com>. For the telephone number to call to speak to a sales specialist, see "[Contacting Dell](#)."

Returning Items for Warranty Repair or Credit

Prepare all items being returned, whether for repair or credit, as follows:

1. Call Dell to obtain an authorization number, and write it clearly and prominently on the outside of the box.

For the telephone number to call, see the [contact numbers](#) for your region.

2. Include a copy of the invoice and a letter describing the reason for the return.
3. Include a copy of the [Diagnostics Checklist](#) indicating the tests you have run and any error messages reported by the Dell Diagnostics.
4. Include any accessories that belong with the item(s) being returned (power cables, software diskettes, guides, and so on) if the return is for credit.
5. Pack the equipment to be returned in the original (or equivalent) packing materials.

You are responsible for paying shipping expenses. You are also responsible for insuring any product returned, and you assume the risk of loss during shipment to Dell. Collect On Delivery (C.O.D.) packages are not accepted.

Returns that are missing any of the preceding requirements will be refused at our receiving dock and returned to you.

Before You Call



NOTE: Have your Express Service Code ready when you call. The code helps Dell's automated-support telephone system direct your call more efficiently.

Remember to fill out the [Diagnostics Checklist](#). If possible, turn on your system before you [call Dell](#) for technical assistance and call from a telephone at or near the computer. You may be asked to type some commands at the keyboard, relay detailed information during operations, or try other troubleshooting steps possible only at the computer system itself. Make sure the system documentation is available.



CAUTION: If you need to remove the computer covers, be sure to first disconnect the computer system's power and modem cables from all electrical outlets.

Diagnostics Checklist

| |
|---|
| Date: |
| Name: |
| Address: |
| Phone number: |
| Service tag (bar code on the back of the computer): |
| Express Service Code: |
| Return Material Authorization Number (if provided by Dell support technician): |
| Operating system and version: |
| Peripherals: |
| Expansion cards: |
| Are you connected to a network? Yes No |
| Network, version, and network card: |
| Programs and versions: |
| Refer to your operating system documentation to determine the contents of the system's start-up files. If the computer is connected to a printer, print each file. Otherwise, record the contents of each file before calling Dell. |
| Error message, beep code, or diagnostic code: |
| Description of problem and troubleshooting procedures you performed: |

[Back to Contents Page](#)

Contacting Dell: Dell™ Latitude™ CPx H-Series/J-Series User's Guide

[Overview](#)

[International Dialing Codes](#)

[Americas Contact Numbers](#)

[Europe Contact Numbers](#)

[Asia and Other Regions Contact Numbers](#)

Overview

When you need to contact Dell, use the telephone numbers, codes, and electronic addresses provided in the following sections. "[International Dialing Codes](#)" provides the various codes required to make long-distance and international calls. "[Americas Contact Numbers](#)," "[Europe Contact Numbers](#)," and "[Asia and Other Regions Contact Numbers](#)" provide local telephone numbers, area codes, toll-free numbers, and e-mail addresses, if applicable, for each department or service available in various countries around the world.

If you are making a direct-dialed call to a location outside of your local telephone service area, determine which codes to use (if any) in "[International Dialing Codes](#)," in addition to the local numbers provided in the other sections.

For example, to place an international call from Paris, France to Bracknell, England, dial the international access code for France followed by the country code for the U.K., the city code for Bracknell, and then the local number as shown in the following illustration:



To place a long-distance call within your own country, use area codes instead of international access codes, country codes, and city codes. For example, to call Paris, France from Montpellier, France, dial the area code plus the local number as shown in the following illustration:



The codes required depend on where you are calling from as well as the destination of your call; in addition, each country has a different dialing protocol. If you need assistance in determining which codes to use, contact a local or an international operator.

 **NOTES:** Toll-free numbers are for use only within the country for which they are listed. Area codes are most often used to call long distance within your own country (not internationally)—in other words, when your call originates in the same country you are calling.

Have your Express Service Code ready when you call. The code helps Dell's automated-support

telephone system direct your call more efficiently.

International Dialing Codes

Click a listed country to obtain the appropriate contact numbers.

| Country (City) | International Access Code | Country Code | City Code |
|--|---------------------------|--------------|--------------|
| Australia (Sydney) | 0011 | 61 | 2 |
| Austria (Vienna) | 900 | 43 | 1 |
| Belgium (Brussels) | 00 | 32 | 2 |
| Brazil | 0021 | 55 | 51 |
| Brunei | — | 673 | — |
| Canada (North York, Ontario) | 011 | — | Not required |
| Chile (Santiago) | — | 56 | 2 |
| China (Xiamen) | — | 86 | 592 |
| Czech Republic (Prague) | 00 | 420 | 2 |
| Denmark (Horsholm) | 009 | 45 | Not required |
| Finland (Helsinki) | 990 | 358 | 9 |
| France (Paris) (Montpellier) | 00 | 33 | (1) (4) |
| Germany (Langen) | 00 | 49 | 6103 |
| Hong Kong | 001 | 852 | Not required |
| Ireland (Bray) | 16 | 353 | 1 |
| Italy (Milan) | 00 | 39 | 2 |
| Japan (Kawasaki) | 001 | 81 | 44 |
| Korea (Seoul) | 001 | 82 | 2 |
| Luxembourg | 00 | 352 | — |
| Macau | — | 853 | Not required |
| Malaysia (Penang) | 00 | 60 | 4 |
| Mexico (Colonia Granada) | 95 | 52 | 5 |
| Netherlands (Amsterdam) | 00 | 31 | 20 |
| New Zealand | 00 | 64 | — |
| Norway (Lysaker) | 095 | 47 | Not required |

| | | | |
|---|--------|-----|--------------|
| Poland (Warsaw) | 011 | 48 | 22 |
| Singapore (Singapore) | 005 | 65 | Not required |
| South Africa (Johannesburg) | 09/091 | 27 | 11 |
| Spain (Madrid) | 07 | 34 | 91 |
| Sweden (Upplands Vasby) | 009 | 46 | 8 |
| Switzerland (Geneva) | 00 | 41 | 22 |
| Taiwan | 002 | 886 | — |
| Thailand | 001 | 66 | — |
| U.K. (Bracknell) | 010 | 44 | 1344 |
| U.S.A. (Austin, Texas) | 011 | 1 | Not required |

Americas Contact Numbers

| Country (City) | Department Name or Service | Area Code | Local Number or Toll-Free Number |
|---|---|---------------------------|----------------------------------|
| Brazil | Sales, Customer Support, Technical Support | | toll free: 0800 90 3355 |
| | Web site: http://www.dell.com.br | | |
| Canada (North York, Ontario) <i>NOTE: Customers in Canada call the U.S.A. for access to TechConnect BBS.</i> | Automated Order-Status System | | toll free: 1-800-433-9014 |
| | AutoTech (Automated technical support) | | toll free: 1-800-247-9362 |
| | Customer Care (From outside Toronto) | | toll free: 1-800-387-5759 |
| | Customer Care (From within Toronto) | 416 | 758-2400 |
| | Customer Technical Support | | toll free: 1-800-847-4096 |
| | Sales (Direct Sales—from outside Toronto) | | toll free: 1-800-387-5752 |
| | Sales (Direct Sales—from within Toronto) | 416 | 758-2200 |
| | Sales (Federal government, education, and medical) | | toll free: 1-800-567-7542 |
| | Sales (Major Accounts) | | toll free: 1-800-387-5755 |
| | TechConnect BBS (Austin, Texas, U.S.A.) | 512 | 728-8528 |
| TechFax | | toll free: 1-800-950-1329 | |
| Chile (Santiago) | Sales, Customer Support, and Technical Support | | toll free: 1230-020-4823 |

| | | | |
|--|---|-----|--|
| <i>NOTE: Customers in Chile call the U.S.A. for sales, customer, and technical assistance</i> | | | |
| Latin America <i>NOTE: Customers in Latin America call the U.S.A. for sales, customer, and technical assistance.</i> | Customer Technical Support (Austin, Texas, U.S.A.) | 512 | 728-4093 |
| | Customer Service (Austin, Texas, U.S.A.) | 512 | 728-3619 |
| | Fax (Technical Support and Customer Service) (Austin, Texas, U.S.A.) | 512 | 728-3883 |
| | Sales (Austin, Texas, U.S.A.) | 512 | 728-4397 |
| | SalesFax (Austin, Texas, U.S.A.) | 512 | 728-4600 728-3772 |
| Mexico (Colonia Granada) <i>NOTE: Customers in Mexico call the U.S.A. for access to the Automated Order-Status System and AutoTech.</i> | Automated Order-Status System (Austin, Texas, U.S.A.) | 512 | 728-0685 |
| | AutoTech (Automated technical support) (Austin, Texas, U.S.A.) | 512 | 728-0686 |
| | Customer Technical Support | 525 | 228-7870 |
| | Sales | 525 | 228-7811 toll free: 91-800-900-37 toll free: 91-800-904-49 |
| | Customer Service | 525 | 228-7878 |
| | Main | 525 | 228-7800 |
| U.S.A. (Austin, Texas) | Automated Order-Status System | | toll free: 1-800-433-9014 |
| | AutoTech (Automated technical support) | | toll free: 1-800-247-9362 |
| | Dell Home and Small Business Group: | | |
| | Customer Technical Support (Return Material Authorization Numbers) | | toll free: 1-800-624-9896 |
| | Customer Service (Credit Return Authorization Numbers) | | toll free: 1-800-624-9897 |
| | National Accounts (systems purchased by established Dell national accounts [have your account number handy], medical institutions, or value-added resellers [VARs]): | | |
| | Customer Service and Technical Support (Return Material Authorization Numbers) | | toll free: 1-800-822-8965 |
| | Public Americas International (systems purchased by governmental agencies [local, | | |

state, or federal] or educational institutions):

| | | |
|---|-----|--|
| Customer Service and Technical Support (Return Material Authorization Numbers) | | toll free: 1-800-234-1490 |
| Dell Sales | | toll free: 1-800-289-3355 toll free: 1-800-879-3355 |
| Spare Parts Sales | | toll free: 1-800-357-3355 |
| DellWare™ | | toll free: 1-800-753-7201 |
| DellWare FaxBack Service | 512 | 728-1681 |
| Fee-Based Technical Support | | toll free: 1-800-433-9005 |
| Sales (Catalogs) | | toll free: 1-800-426-5150 |
| Fax | | toll free: 1-800-727-8320 |
| TechFax | | toll free: 1-800-950-1329 |
| TechConnect BBS | 512 | 728-8528 |
| Dell Services for the Deaf, Hard-of- Hearing, or Speech-Impaired | | toll free: 1-877-DELLTTY (1-877-335-5889) |
| Switchboard | 512 | 338-4400 |

Europe Contact Numbers

| Country (City) | Department Name or Service | Area Code | Local Number or Toll-Free Number |
|---|---|-----------|----------------------------------|
| Austria (Vienna) <i>NOTE: Customers in Austria call Langen, Germany for Technical Support and Customer Care.</i> | Switchboard | 01 | 491 040 |
| | Home/Small Business Sales | 01 | 795676-02 |
| | Home/Small Business Sales Fax | 01 | 795676-05 |
| | Home/Small Business Customer Care | 01 | 795676-03 |
| | Preferred Accounts/Corporate Customer Care | | 0660-8056 |
| | Home/Small Business Technical Support | 01 | 795676-04 |
| | Preferred Accounts/Corporate Technical Support | | 0660-8779 |
| | Web site: http://support.euro.dell.com/at | | |
| | E-mail: tech_support_germany@dell.com | | |
| Belgium | Technical Support | 02 | 481 92 88 |

| | | | |
|--|---|----|-----------------------|
| (Brussels) | Customer Care | 02 | 481 91 19 |
| | Home/Small Business Sales | | toll free: 0800 16884 |
| | Corporate Sales | 02 | 481 91 00 |
| | Fax | 02 | 481 92 99 |
| | Switchboard | 02 | 481 91 00 |
| | Web site: http://support.euro.dell.com/be | | |
| | E-mail: tech_be@dell.com | | |
| Czech Republic (Prague) | Technical Support | 02 | 22 83 27 27 |
| | Customer Care | 02 | 22 83 27 11 |
| | Fax | 02 | 22 83 27 14 |
| | TechFax | 02 | 22 83 27 28 |
| | Switchboard | 02 | 22 83 27 11 |
| | Web site: http://support.euro.dell.com/cz | | |
| | E-mail: czech_dell@dell.com | | |
| Denmark (Horsholm) <i>NOTE: Customers in Denmark call Sweden for fax technical support.</i> | Technical Support | | 45170182 |
| | Relational Customer Care | | 45170184 |
| | Home/Small Business Customer Care | | 32875505 |
| | Switchboard | | 45170100 |
| | Fax Technical Support (Upplands Vasby, Sweden) | | 859005594 |
| | Fax Switchboard | | 45170117 |
| | Web site: http://support.euro.dell.com/dk | | |
| | E-mail: den_support@dell.com | | |
| Finland (Helsinki) | Technical Support | 09 | 253 313 60 |
| | Technical Support Fax | 09 | 253 313 81 |
| | Relational Customer Care | 09 | 253 313 38 |
| | Home/Small Business Customer Care | 09 | 693 791 94 |
| | Fax | 09 | 253 313 99 |
| | Switchboard | 09 | 253 313 00 |
| | | | |

| | | | |
|--------------------------------------|---|-------|---------------|
| | Web site: http://support.euro.dell.com/fi | | |
| | E-mail: fin_support@dell.com | | |
| France (Paris/Montpellier) | Technical Support | 0803 | 387 270 |
| | Customer Care (Paris) | 01 | 47 62 68 92 |
| | Customer Care (Montpellier) | 04 | 67 06 61 96 |
| | TechConnect BBS (Montpellier) | 04 | 67 22 53 04 |
| | Fax (Montpellier) | 04 | 67 06 60 07 |
| | Switchboard (Paris) | 01 | 47 62 69 00 |
| | Switchboard (Montpellier) | 04 | 67 06 60 00 |
| | Web site: http://support.euro.dell.com/fr | | |
| | E-mail: web_fr_tech@dell.com | | |
| Germany (Langen) | Technical Support | 06103 | 766-7200 |
| | Technical Support Fax | 06103 | 766-9222 |
| | Home/Small Business Customer Care | | 0180-5-224400 |
| | Global Segment Customer Care | 06103 | 766-9570 |
| | Preferred Accounts Customer Care | 06103 | 766-9420 |
| | Large Accounts Customer Care | 06103 | 766-9560 |
| | Public Accounts Customer Care | 06103 | 766-9555 |
| | TechConnect BBS | 06103 | 766-9666 |
| | Switchboard | 06103 | 766-7000 |
| | Web site: http://www.dell.de/support | | |
| | E-mail: tech_support_germany@dell.com | | |
| Ireland (Bray) | Technical Support | | 1-850-543-543 |
| | Customer Care | 01 | 204 4026 |
| | Sales | | 1-850-235-235 |
| | SalesFax | 01 | 286 2020 |
| | Fax | 01 | 286 6848 |
| | TechConnect BBS | 01 | 204 4711 |
| | TechFax | 01 | 204 4708 |
| | | | |

| | | | |
|---|--|-----|----------------------|
| | Switchboard | 01 | 286 0500 |
| | Web site: http://support.euro.dell.com/ie | | |
| | E-mail: dell_direct_support@dell.com | | |
| Italy (Milan) | Technical Support | 2 | 57782.690 |
| | Customer Care | 2 | 57782.555 |
| | Sales | 2 | 57782.411 |
| | Fax | 2 | 57503530 |
| | Switchboard | 2 | 57782.1 |
| | Web site: http://support.euro.dell.com/it | | |
| | E-mail: support_italy@dell.com | | |
| Luxembourg <i>NOTE: Customers in Luxembourg call Belgium for sales, customer, and technical assistance.</i> | Technical Support (Brussels, Belgium) | 02 | 481 92 88 |
| | Home/Small Business Sales (Brussels, Belgium) | | toll free: 080016884 |
| | Corporate Sales (Brussels, Belgium) | 02 | 481 91 00 |
| | Customer Care (Brussels, Belgium) | 02 | 481 91 19 |
| | Switchboard (Brussels, Belgium) | 02 | 481 91 00 |
| | Fax (Brussels, Belgium) | 02 | 481 92 99 |
| | Web site: http://support.euro.dell.com/be | | |
| | E-mail: tech_be@dell.com | | |
| Netherlands (Amsterdam) | Technical Support | 020 | 581 8838 |
| | Customer Care | 020 | 581 8740 |
| | Home/Small Business Sales | | toll free: 0800-0663 |
| | Home/Small Business Sales Fax | 020 | 682 7171 |
| | Corporate Sales | 020 | 581 8818 |
| | Corporate Sales Fax | 020 | 686 8003 |
| | Fax | 020 | 686 8003 |
| | Switchboard | 020 | 581 8818 |
| | Web site: http://support.euro.dell.com/nl | | |
| | | | |

| | | | |
|---|---|----|-------------|
| | E-mail: tech_nl@dell.com | | |
| Norway (Lysaker) <i>NOTE: Customers in Norway call Sweden for fax technical support.</i> | Technical Support | | 671 16882 |
| | Relational Customer Care | | 671 17514 |
| | Home/Small Business Customer Care | | 231 62298 |
| | Switchboard | | 671 16800 |
| | Fax Technical Support (Upplands Vasby, Sweden) | | 590 05 594 |
| | Fax Switchboard | | 671 16865 |
| | Web site: http://support.euro.dell.com/no | | |
| | E-mail: nor_support@dell.com | | |
| Poland (Warsaw) | Technical Support | 22 | 60 61 999 |
| | Customer Care | 22 | 60 61 999 |
| | Sales | 22 | 60 61 999 |
| | Switchboard | 22 | 60 61 999 |
| | Fax | 22 | 60 61 998 |
| | Web site: http://support.euro.dell.com/pl | | |
| | E-mail: pl_support@dell.com | | |
| Spain (Madrid) | Technical Support | | 902 100 130 |
| | Corporate Customer Care | | 902 118 546 |
| | Home/Small Business Customer Care | | 902 118 540 |
| | TechConnect BBS | 91 | 329 33 53 |
| | Corporate Sales | | 902 100 185 |
| | Home/Small Business Sales | | 902 118 541 |
| | Switchboard | 91 | 722 92 00 |
| | Web site: http://support.euro.dell.com/es | | |
| | E-mail: es_support@dell.com | | |
| Sweden (Upplands Vasby) | Technical Support | 08 | 590 05 199 |
| | Relational Customer Care | 08 | 590 05 642 |
| | Home/Small Business Customer Care | 08 | 587 70 527 |
| | Fax Technical Support | 08 | 590 05 594 |

| | | | |
|--------------------------------|--|-------|---------------|
| | Sales | 08 | 590 05 185 |
| | Web site: http://support.euro.dell.com/se | | |
| | E-mail: swe_support@dell.com | | |
| Switzerland (Geneva) | Technical Support | | 0844 811 411 |
| | Customer Care | | 0848 802 802 |
| | Switchboard | 022 | 799 01 01 |
| | Fax | 022 | 799 01 90 |
| | Web site: http://support.euro.dell.com/ch | | |
| | E-mail: swisstech@dell.com | | |
| U.K. (Bracknell) | Technical Support | | 0870-908-0800 |
| | Corporate Customer Care | 01344 | 720206 |
| | Home/Small Business Customer Care | | 0870-906-0010 |
| | TechConnect BBS | | 0870-908-0610 |
| | Sales | 01344 | 720000 |
| | AutoFax | | 0870-908-0510 |
| | Web site: http://support.euro.dell.com/uk | | |
| | E-mail: dell_direct_support@dell.com | | |

Asia and Other Regions Contact Numbers

| Country (City) | Department Name or Service | Area Code | Local Number or Toll-Free Number |
|------------------------------|--|-----------|----------------------------------|
| Australia (Sydney) | Home and Small Business | | 1-300-65-55-33 |
| | Government and Business | | toll free: 1-800-633-559 |
| | Preferred Accounts Division (PAD) | | toll free: 1-800-060-889 |
| | Customer Care | | toll free: 1-800-819-339 |
| | Corporate Sales | | toll free: 1-800-808-385 |
| | Transaction Sales | | toll free: 1-800-808-312 |
| | Fax | | toll free: 1-800-818-341 |
| Brunei | Customer Technical Support (Penang, Malaysia) | | 810 4966 |

| | | | |
|--|--|-----|---|
| <i>NOTE: Customers in Brunei call Malaysia for customer assistance.</i> | Customer Service (Penang, Malaysia) | | 810 4949 |
| | Transaction Sales (Penang, Malaysia) | | 810 4955 |
| China (Xiamen) | Customer Service | | toll free: 800 858 2437 |
| | Sales | | toll free: 800 858 2222 |
| Hong Kong <i>NOTE: Customers in Hong Kong call Malaysia for customer assistance.</i> | Technical Support | | toll free: 800 96 4107 |
| | Customer Service (Penang, Malaysia) | | 810 4949 |
| | Transaction Sales | | toll free: 800 96 4109 |
| | Corporate Sales | | toll free: 800 96 4108 |
| Japan (Kawasaki) | Technical Support (Server) | | toll free: 0120-1984-35 |
| | Technical Support (Dimension™ and Inspiron™) | | toll free: 0120-1982-56 or 0088- 25-3355 |
| | Technical Support (WorkStation, OptiPlex™, and Latitude™) | | toll free: 0120-1984-39 or 0088- 22-7890 |
| | Y2K Support | 044 | 556-4298 |
| | Customer Care | 044 | 556-4240 |
| | Home and Small Business Group Sales | 044 | 556-3344 |
| | Preferred Accounts Division Sales | 044 | 556-3433 |
| | Large Corporate Accounts | 044 | 556-3430 |
| | Faxbox Service | | 03-5972-5840 |
| | Switchboard | 044 | 556-4300 |
| Korea (Seoul) | Technical Support | | toll free: 080-200-3800 |
| | Sales | | toll free: 080-200-3777 |
| | Customer Service (Penang, Malaysia) | | 604-810-4949 |
| | Customer Service (Seoul, Korea) | | 2194-6220 |
| | Fax | | 2194-6202 |
| | Switchboard | | 2194-6000 |
| Macau <i>NOTE: Customers in</i> | Technical Support | | toll free: 0800 582 |
| | Customer Service (Penang, Malaysia) | | 810 4949 |
| | Transaction Sales | | toll free: 0800 581 |

| | | | |
|---|---|-----|--------------------------|
| <i>Macau call Malaysia for customer assistance.</i> | | | |
| Malaysia (Penang) | Technical Support | | toll free: 1 800 888 298 |
| | Customer Service | 04 | 810 4949 |
| | Transaction Sales | | toll free: 1 800 888 202 |
| | Corporate Sales | | toll free: 1 800 888 213 |
| New Zealand | Home and Small Business | | 0800 446 255 |
| | Government and Business | | 0800 444 617 |
| | Sales | | 0800 441 567 |
| | Fax | | 0800 441 566 |
| Singapore (Singapore) <i>NOTE: Customers in Singapore call Malaysia for customer assistance.</i> | Technical Support | | toll free: 800 6011 051 |
| | Customer Service (Penang, Malaysia) | 04 | 810 4949 |
| | Transaction Sales | | toll free: 800 6011 054 |
| | Corporate Sales | | toll free: 800 6011 053 |
| South Africa (Johannesburg) | Technical Support | 011 | 709 7710 |
| | Customer Care | 011 | 709 7710 |
| | Sales | 011 | 706 7700 |
| | Fax | 011 | 709 0495 |
| | Switchboard | 011 | 709 7700 |
| | Web site: http://support.euro.dell.com/za | | |
| | E-mail: dell_za_support@dell.com | | |
| Southeast Asian/Pacific Countries (excluding Australia, Brunei, China, Hong Kong, Japan, Korea, Macau, Malaysia, New Zealand, | Customer Technical Support, Customer Service, and Sales (Penang, Malaysia) | | 60 4 810-4810 |

| | | | |
|--|-------------------------------------|--|--|
| Singapore, Taiwan, and Thailand—refer to individual listings for these countries) | | | |
| Taiwan | Technical Support | | toll free: 0080 60 1225 |
| | Technical Support (Servers) | | toll free: 0080 60 1256 |
| | Customer Service (Penang, Malaysia) | | 810 4949 |
| | Transaction Sales | | toll free: 0080 651 228/0800 33 556 |
| | Corporate Sales | | toll free: 0080 651 227/0800 33 555 |
| Thailand <i>NOTE: Customers in Thailand call Malaysia for customer assistance.</i> | Technical Support | | toll free: 088 006 007 |
| | Customer Service (Penang, Malaysia) | | 810 4949 |
| | Sales | | toll free: 088 006 009 |

[Back to Contents Page](#)